

PVC
WINDOW
& DOOR
SYSTEMS

 **winhouse**[®]



CONTENTS



4	ABOUT US
6	GOAL, VALUES & TARGETS
7	PRODUCT RANGE
8	EXPORT
12	FUDEL
14	OUR POLICY AND UNDERSTANDING OF QUALITY
16	OUR CERTIFICATES OF QUALITY
17	OUR FIRSTS, INNOVATION AND R&D
20	PVC PROFILE DEALERS TRAINING
22	OUR ENVIRONMENTAL POLICY
23	ENVIRONMENTAL DECLARATION
24	OUR OCCUPATIONAL HEALTH AND SAFETY POLICY
26	INTEGRATED PRODUCTION
28	PROFILES
29	EDPM SEALS
30	TPE SEALS
31	REINFORCEMENT STEEL
32	ACCESSORIES
34	NOISE AND HEAT INSULATION
36	WIND LOAD RESISTANCE
38	PERSPIRATION AND PVC WINDOW USAGE
40	PENESCOPE
41	LAMINATED WINDOWS
43	SERIES
46	DIAMOND
50	GARNET & GARNET SELECTIVE
54	GARNET SELECTIVE STRONG & GARNET STRONG
58	SELENİT & SELENİT SELECTIVE
62	SELENİT SELECTIVE STRONG & SELENİT STRONG
66	ELEGANCE & ELEGANCE SELECTIVE
70	ZENIA SLIDE (SLIDING WITH INSULATION)
74	ANDES SLIDE & ANDES
78	SLIDING SYSTEMS (70 MM & 75 MM)
81	SHUTTER SYSTEMS
82	DETAILED PROFILES
84	ROLLER BLIND SYSTEMS
88	ALTERNATIVE SYSTEMS
90	AUTOMATIC SLIDING SYSTEM
91	FOLDING WINDOW AND DOOR SYSTEMS
92	PIVOT WINDOWS
93	WINDOW WITH ADAPTER
94	PROJECTS

ABOUT US

Firat Plastik Kauçuk Sanayi ve Ticaret AŞ, was established in 1972 to carry out production in the field of plastic building materials. Firat, which always sets out with the principles of quality production and product diversity, has succeeded in becoming both the leading establishment of the sector and the export leader of the sector as a result of significant investments that have taken years.

In its production, Firat targets various sectors such as construction, agriculture, automotive, medical, domestic appliances sectors with its plastic-based products. It realizes its production targeting those sectors in its modern factories in Büyükçekmece-İstanbul and Sincan-Ankara which have a total area that reaches 750,000 m2 with its expert staff and is one of three biggest plastic production complexes in Europe. Firat, which adopted sustainability and producing more ecologic and innovative products in order to leave more livable environment to future generations, is the leader and pioneering company in pvc window sector.

Firat's worldwide shining PVC door and window brand Winhouse, with over 300 sales points spread throughout Turkey, serves its customers with its innovative and rich product range. Winhouse which meets the expectations of final consumers, architects and engineers with product lines such as Redonit 85, Elegance 80, Elegance Selective, Selenit 75, Selenit Selective, Selenit Selective Strong,

Selenit Strong, Garnet 70, Garnet Selective Strong, Garnet Selective, Garnet Strong, Diamond 60, Opal 70, Andes & Andes Slide, Zenia Slide, Zenia Hebeschiebe, Mono-Block Roller Blinds offers window systems suitable to every project. Winhouse provides solutions with rich detailed and auxiliary profiles to non- standard architectural designs such as pivot, parallel sliding, folding window, guillotine and offers decorative alternatives to the living areas with different color options. Winhouse which carries out its profile production in accordance with the international EN and TSE norms, achieved top level quality inspection with FUEDEL, the first accredited window laboratory

in the sector. As of the beginning of 2018, the number of personnel working under Firat structure is 1850. Firat believes that the most valuable element is human and always organizes in-service trainings with the aim of enhancing work experience of its employees and building up their corporate knowledge. With its 100% domestic capital, Winhouse is the leading company drawing its strength from these lands. It invests in this country and heeds the national standing. It is success-oriented and protects the social responsibilities. It transforms information to technology for the development of its country and sector.



WINHOUSE PVC PROFILE MANUFACTURING FACILITIES

4

5



FIRAT MANUFACTURING FACILITIES

GOALS,
VALUES &
TARGETS



PRODUCT
RANGE



GOAL

To manufacture PVC Window and Door Systems which are made of plastic and composite materials, pipe systems for indoor installations and outdoor infrastructures, plastic pipes and fittings required for medical devices and agricultural irrigation applications which will provide the highest benefit to our customers with the minimum cost, by protecting sustainable growth and environment with high quality and innovation and to increase

VALUES

- Corporate culture which takes its source from our social culture and values
- To be true and lasting example for the future generations
- Determination and ambition
- Devotion
- Innovation
- Reliability
- Participation
- Transparency
- Responsibility
- Consistency
- Commitment
- Honesty
- Entrepreneurship

TARGETS

To utilize all its sources, develop, grow and struggle to achieve perfection and excellence through advanced technology are the objectives of Winhouse. As a natural result of Winhouse's objective of achieving perfection and excellence, our products are preferred thanks to being reliable, strong, easily accessible, easy-to-use, sustainable, ecologic and having after-sale support.



6 7



Firat, has a product range of over 5000 products. In order to ensure that our customers get the most beneficial and satisfactory service, Firat products are manufactured as integrated systems (parts complementing each other).

Thousands of Firat products, such as PVC Window and Door Profiles, Reinforcement Steels, Production of EPDM and TPE seals, metal injection products (hinges and window connection components), Window Handles, PVC rain gutters, PVC waste water pipes and fittings, PVC hose groups, rubber and PE-based hoses, PPRC sanitary installation pipes and fittings, PP composite pipes and fittings, HDPE pipes and fittings, PP&PE sheets, LDPE pipes and fittings, EF fittings, PE fittings, PE 80 natural gas pipes, PVC and PE drainage pipes, FKS sewage pipes, FCS pipe systems, tunnel type drainage pipes, double-walled cable protection pipes, PEX mobile system and floor heating pipes, PEX pipe metal fittings, PEX-AL-PEX pipes and press fittings, Pert Pipes, Pert-Al-Pert pipes, metal valves for gas and drinking water, irrigation pipes and drip watering pipes are at the service of customers in Turkey and many other points in the world.

Exempting glass and screws, Winhouse is the only company that manufactures all parts constituting PVC window and door systems in the world plastics sector. Since one hundred percent compatibility between the components of PVC window and door frame systems can only be achieved by producing all of these under the same roof, all PVC profiles, EPDM seals, TPE seals, reinforcement steels and metal accessories are manufactured and integrated by Firat in its own facility.

After all the quality control tests are completed, Firat products are offered to the market with Firat Quality Assurance Confirmation. Firat is the only company in the sector which holds national and international quality certificates such as DVGW, SKZ, AENOR, GOST, EMI, TSE as well as all of the ISO 14001, OHSAS 18001, ISO 10002, ISO 9001 and ISO17025 system certificates.

EXPORT

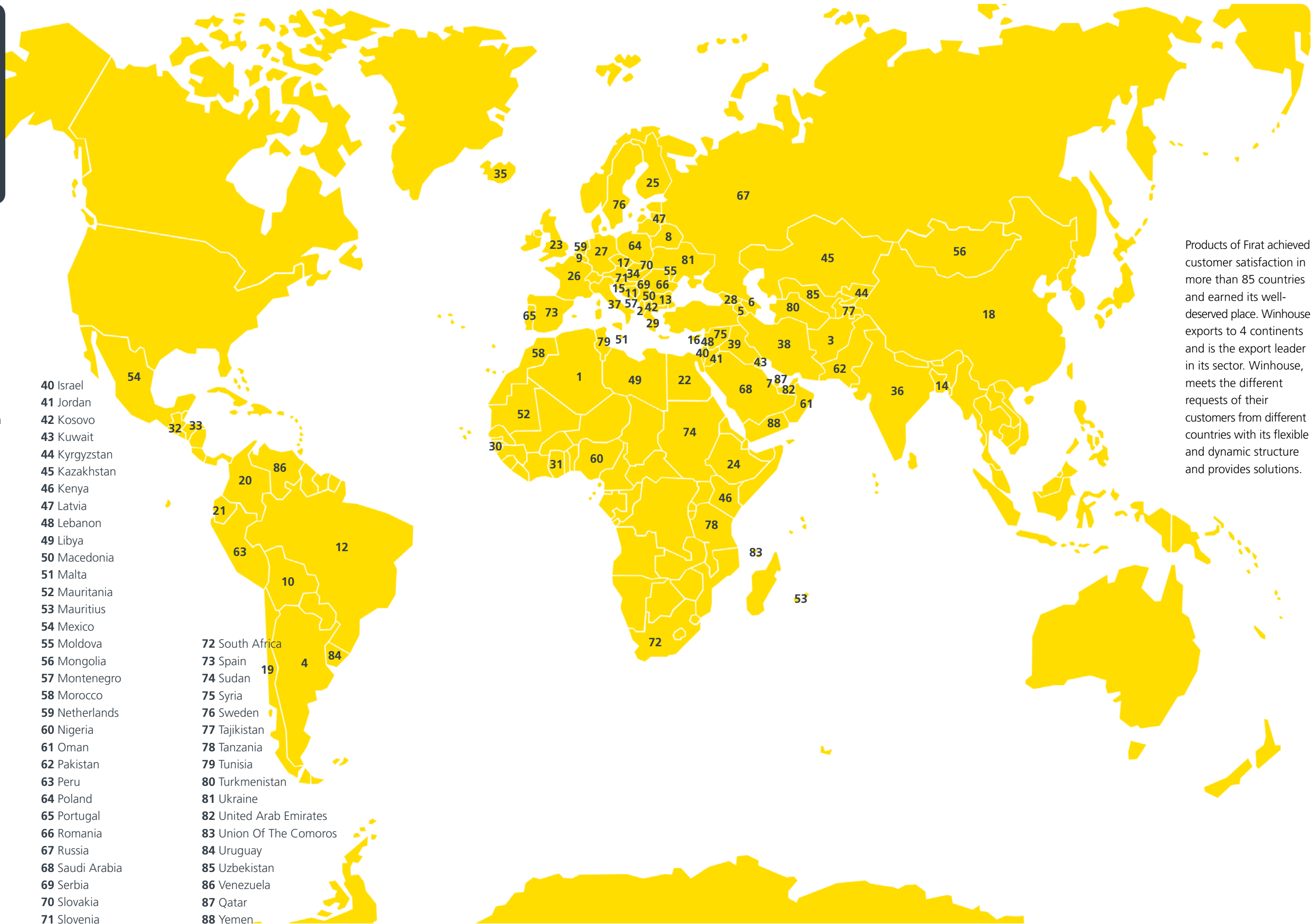

- 1 Algeria
- 2 Albania
- 3 Afghanistan
- 4 Argentina
- 5 Armenia
- 6 Azerbaijan
- 7 Bahrain
- 8 Belarus
- 9 Belgium
- 10 Bolivia
- 11 Bosnia&Herzegovina
- 12 Brazil
- 13 Bulgaria
- 14 Bangladesh
- 15 Croatia
- 16 Turkish Republic of Northern Cyprus
- 17 Czech Republic
- 18 China
- 19 Chile
- 20 Colombia
- 21 Ecuador
- 22 Egypt
- 23 England
- 24 Ethiopia
- 25 Finland
- 26 France
- 27 Germany
- 28 Georgia
- 29 Greece
- 30 Gambia
- 31 Ghana
- 32 Guatemala
- 33 Honduras
- 34 Hungary
- 35 Iceland
- 36 India
- 37 Italy
- 38 Iran
- 39 Iraq
- 40 Israel
- 41 Jordan
- 42 Kosovo
- 43 Kuwait
- 44 Kyrgyzstan
- 45 Kazakhstan
- 46 Kenya
- 47 Latvia
- 48 Lebanon
- 49 Libya
- 50 Macedonia
- 51 Malta
- 52 Mauritania
- 53 Mauritius
- 54 Mexico
- 55 Moldova
- 56 Mongolia
- 57 Montenegro
- 58 Morocco
- 59 Netherlands
- 60 Nigeria
- 61 Oman
- 62 Pakistan
- 63 Peru
- 64 Poland
- 65 Portugal
- 66 Romania
- 67 Russia
- 68 Saudi Arabia
- 69 Serbia
- 70 Slovakia
- 71 Slovenia
- 72 South Africa
- 73 Spain
- 74 Sudan
- 75 Syria
- 76 Sweden
- 77 Tajikistan
- 78 Tanzania
- 79 Tunisia
- 80 Turkmenistan
- 81 Ukraine
- 82 United Arab Emirates
- 83 Union Of The Comoros
- 84 Uruguay
- 85 Uzbekistan
- 86 Venezuela
- 87 Qatar
- 88 Yemen

Products of Firat achieved customer satisfaction in more than 85 countries and earned its well-deserved place. Winhouse exports to 4 continents and is the export leader in its sector. Winhouse, meets the different requests of their customers from different countries with its flexible and dynamic structure and provides solutions.



FIRAT MADE ITS MARK IN HISTORY WATER HAS REACHED TO TRNC "Sea Transmission" which is the most critical step of Drinking Water Supply Project in T.R.N.C., has been overcome with professional engineering knowledge, experience, speed of production and the successes which have entered into the world plastic literature. Firat with 100% Turkish Capital has become the pipe provider of this project since it has capacity to manufacture 100 PE pipes manufactured as one piece each of which have a length of 500 meters in total longer than 80.000 meters by itself alone in such a short term as one year in the whole world. Firat has established a factory in an area of 85.000 square

meters in Mersin-Taşucu Seka Harbour. Sea Transmission has characteristics of 80 kilometers 151 meters of length, depth of 250 meters and hung PE 100 pipe line and being a first in the world 75 million cubic meters of water is going to be delivered to TRNC with this enormous project and TRNC will have a source to be supplied with water in a perspective of 50 years.

Diameter of Pipes: **1600 mm**
 Classification of Raw Material: **HDPE PE 100 LS (LOW SAGGING)**
 Operating Pressure: **PN 6,4 (SDR 26) / PN 8 (SDR 21)**
 Length of the Pipes: **500 m (160 pcs)**
 500 m Pipe Gap: **148 ton**
 Amount of Raw Material: **25.000 tons**

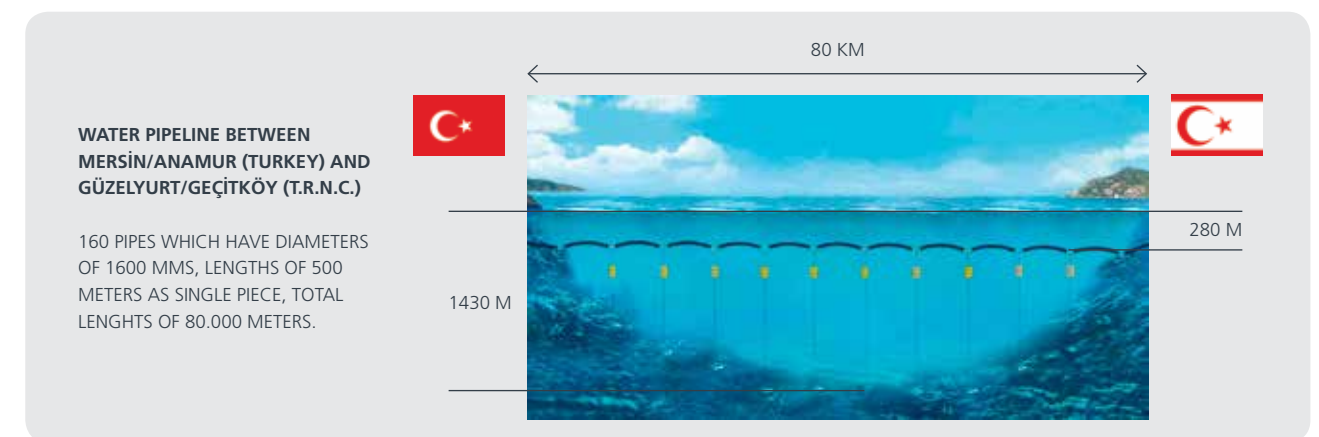



When considering the production amounts of PVC Windows and Door Systems, our country takes the second place by means of tonnage in Europe. In our country where construction sector improves rapidly, 80% of the windows installed in new constructions are PVC windows. When production amount and usage rates are taken into consideration, it can be seen that window sector has a significant share in our country. However, in our country where tons of window-door profiles are manufactured, determination of performance characteristics of window-door systems built with these profiles and providing the results in an independent, unbiased and reliable way was a huge gap. Winhouse being the possessor of the firsts in the sector, established Turkey's "first and only" TÜRKAK accredited "Window Laboratory" with 100% Turkish capital and offered it for servicing the sector. FUDEL (Firat Conformity Evaluation Laboratory), service scope consists of following tests.

STANDARDS CONCERNING TESTS

Resistance to Wind Load **TS 4644 EN 12211**

Air Permeability **TS EN 1026**

Water Impermeability **TS EN 1027**

Load Bearing Capacity of Safety Systems **TS EN 14609**

Calculation of Heat Transmission of Windows, Doors and Shutters **TS EN ISO 10077-1**



FUDEL is able to carry out tests of associations and institutions which carry out market inspection and supervision in addition to type tests of window and accessory manufacturers operating in the sector, with its scope of service. This way; flow of national sources to abroad by sending specimens for testing the specimens taken from the market will be prevented and in addition to the contribution provided for the country's economy market inspection and supervision activities will be rendered more active.

Windows are of the most important elements of a structure with the insulation, aesthetics and easy usage they provide. Also, with heat insulation it provides, it is an element that pays off itself on the structure, also ensures comfortable environments with the high level of sound insulation. Today, while making design our architects consider not only the visual and architectural aspects but also the window performance in order to prevent the unchecked problems.

FUDEL aims to provide service to the entire sector in the fields of 'importance of window, engineering calculations of window, personnel training on window'. In these courses, hands on training will be provided to architects and construction companies regarding

static calculations for window designing, profile series, auxiliary materials, accessories to be used and glass selection according to the data obtained from these calculations.

FUDEL also continues to organize training days which will be open for the participation of public institutions, construction companies and private associations and institutions to describe the importance of window in Turkey, to prevent erroneous applications and to offer higher quality products to the final customers.



QUALITY UNDERSTANDING & POLICY

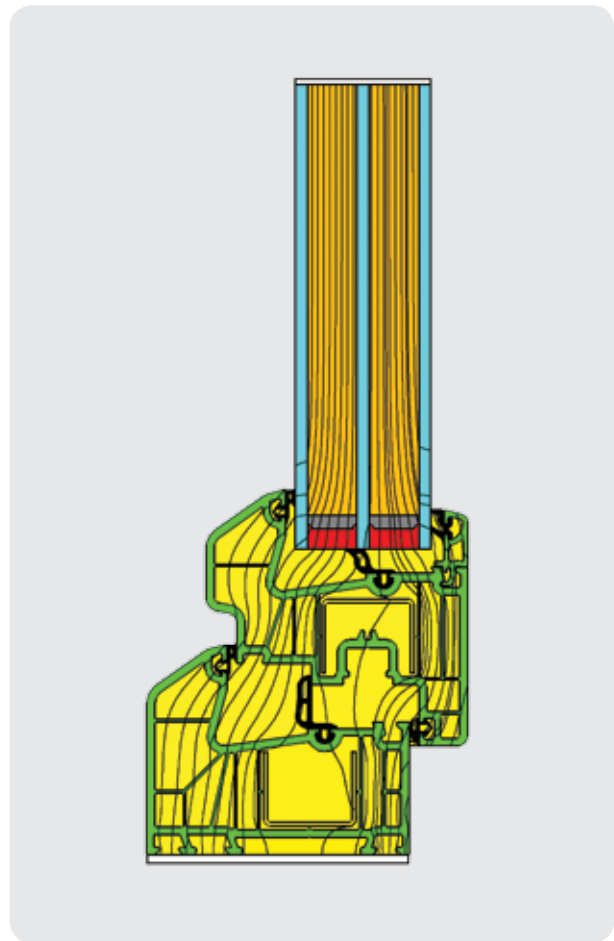

HEAT FLOW DIAGRAM

QUALITY POLICY

I am a precious and hardworking individual. I offer my labor, intelligence, knowledge and skill. My colleagues are also hardworking and competent people. Common beliefs and values of us, employees, create "Company Culture of Firat". Quality is the core of modern life. I have to transform my customers' expectations into customer satisfaction. In order to achieve that, I meet all of my customers' expectations, and provide my products and services in compliance with national and international standards and values.



WINDOW PERFORMANCE TESTS

This is my conscientious duty. However, I constitute a whole, together with all the other employees. I share what I know and learn what I do not know from those who know it. Our partnership on knowledge and skill makes us an insuperable team. Our efforts complementing each other ensure that we obtain superior quality all the time. I carry out my responsibility properly and at once in order to improve myself, my company and my country.

This is my humanitarian obligation. I fastidiously comply with the new principles which modern business life and competitive economy entail. It is my duty to decrease costs,



QUALITY UNDERSTANDING
The quality control processes that are carried out in Winhouse laboratories consist of three phases.

- Input Quality Control
- Process Quality Control
- Output-Final Quality Control

Input Quality Control

Quality Control tests complying with the quality-production standards set by Winhouse are applied to all types of raw materials and auxiliary materials coming from our suppliers. After samples taken in the scope of "Sampling for Approval" standards from each lot of raw materials and auxiliary materials supplied in lots by our suppliers have to pass from the tests of Physical Compliance, Chemical Compliance, Density, MFI, Humidity, Bulk Density, Viscosity Number, Distribution of Grain Thickness, K Number and Homogeneity in the Entrance Quality Control laboratories, it is compulsory that raw material obtains "Suitable for Production" approval.

Process Quality Control

In the production process carried out with raw materials and auxiliary materials bearing "Suitable for Production" approval, samples taken from the production lines during or soon after production are passed through the Process Quality Control tests determined by national (TSE) and international (SKZ, EN, DIN etc.) quality standard institutions in Winhouse laboratories, and recorded regularly. Main Process Quality Control tests are as follows.

- Test for Impact Resistance at Cold
- Test for Dent Impact Resistance
- Elongation Test, Density Test
- Vicat Test, Wind Load Resistance Test
- Water Impermeability Test
- Air Permeability Test
- Corner Welding Test

Output-Final Quality Control

It is compulsory that after our products which have obtained quality approval pass through Packaging Compliance, Pack Compliance, Description and Label Compliance checks following automatic packaging and wrapping processes, they get "Suitable for Shipping" approval. Also, apart from the quality control tests conducted in Winhouse laboratories, all our products are sampled from our production lines twice a year regularly, and subjected to quality control tests by the representatives of international test and certification institutions such as TSE, SKZ, IFT etc. Our products which have passed through all these tests and met the required quality conditions are offered for the use of our customers.

bring new Technologies in our constitution, increase our competitive power and produce knowledge, skill and solution. And the quality of our products, efficiency of our efforts and delivering services and products on time are my duties.

This is my national duty. Behind the interest shown to us and our products, lays this partnership agreement and this confidence. For my company and for me, this confidence is "Quality Policy". In order to comply with the commitments stated above Winhouse, Quality Management System is established and promises to perform the requirements of this system and to improve the efficiency of this system constantly.

**OUR
CERTIFICATES
OF QUALITY**



**FIRSTS,
INNOVATION &
R&D**

Winhouse, one of the leading brands in Turkey and in the world for PVC Door and window systems, has brought a lot of innovation for the development and increased the importance of the sector as a result of the emphasis placed on innovation and R&D works.

- Some of these are;
- During the years when Turkish market were dominated by the turn only windows, Firat released turn and tilt window systems which have much more insulation value but which were not preferred by the masses due to their high costs and made these systems affordable for the finals consumers. (Year 2000)
- In the period in which 60 mm profile width was dominant in the sector Winhouse released its 70mm profile system with 5 chambers which increased the insulation and resistance values in high-rise buildings, blazed a trail in PVC window and door systems, raised the standard of the sector. (Year 2004)
- Winhouse which started the works for CE markings, a legal obligation in Door and Window systems in Turkey and established the system by providing training in points of sale with regard to CE marking, blazed another trail with this work for the purpose of increasing the quality in the sector. (Year 2007)



→ In this period in which wooden pattern systems are used scarcely due to their high costs Winhouse made wooden pattern windows affordable to the final customers and lead the way for the sector which was in trouble due to Asian Crisis. (Year 2009)
 → Turkey is one of the leading companies in PVC profile but until 2010 there have not been any accredited laboratory in which “window tests” could be carried out in our country. Winhouse blazed a trail with regard to this matter and introduced FUEDEL, the first accredited window laboratory of Turkey into the sector. (Year 2010)
 → Knowing that training is the most important shortness of the sector, Winhouse created the “Certified Assembly Personnel” standard which was unavailable in our country for the purpose of increasing the quality during the assembly stage, one of the most important points in PVC window systems and train certified assembly personnel with regard to this matter; this standard has been approved by the Institute of Vocational Education and has been put into the service for the sector to use. This was a big step for the development of the sector. Winhouse blazed a trail again and subjected the assembly personnel of the point of sales to test and awarded the successful personnel with Certificates with TÜRKAK accreditation. (Year 2014)

→ In a time when the general standard of the sector was 70 mm line and insulation values became more important, Winhouse gave up from 70 mm profile systems and preferred 75mm system with 6 chambers and again blazed the trail in the sector. (Year 2015)
 → Knowing that sliding systems can be used within a limited geography and sliding systems with high insulation can be bought with a high cost, Winhouse designed the Zenia Slide which is a first in Turkey. With Zenia Slide insulation is achieved via the EPDM seals from all points when the window is closed and effects such as wind, noise and rain from outdoors are completely prevented to reach indoors. (Year 2015)
 → Winhouse R&D team who follow the home decoration products and colors which are trending in the world closely, meet the different decorative expectations with 21 different colors by taking the laminate covered profiles out of the wooden perception. (Year 2015)
 → Environments and high-rise buildings exposed to the high wind loads, should both prefer the windows with high performance values. Redonit has 85 mm profile width, three self-sealing system, 7-chambered design, A Class wall thickness and glazing up to 44 mm is possible by using triple glazing beads, that’s why heat and sound insulation reaches the maximum value. (Year 2016)



Winhouse has always blazed the trail in the sector with its R&D works. With its technical staff, accumulated knowledge and market researches shaping the future, designed products are turned into prototypes and subjected to all the tests stipulated by European Standards in our laboratory, product development is carried out by subjecting them to tests and applications in the window production facility under our laboratory before introduced to the market. The cooperation between our technical staff and our esteemed dealers during the design and R&D stage, the resulting product has top level success. High heat and sound insulation window series, just like the Redonit Series, should be preferred in high-rise buildings and areas with high wind loads. Elegance A and Elegance Selective which have class “A” wall thicknesses are the new solution partners of new Projects with their 80 mm profile width and triple self-sealed system. (Year 2016)

Zenia Hebeschiebe system, which has been developed by attaching aluminum case and aluminum double rail adapter used in the lower base to the profiles of the Zenia Slide systems, ensures wider and higher gaps to be sealed through high insulation. (Year 2018)

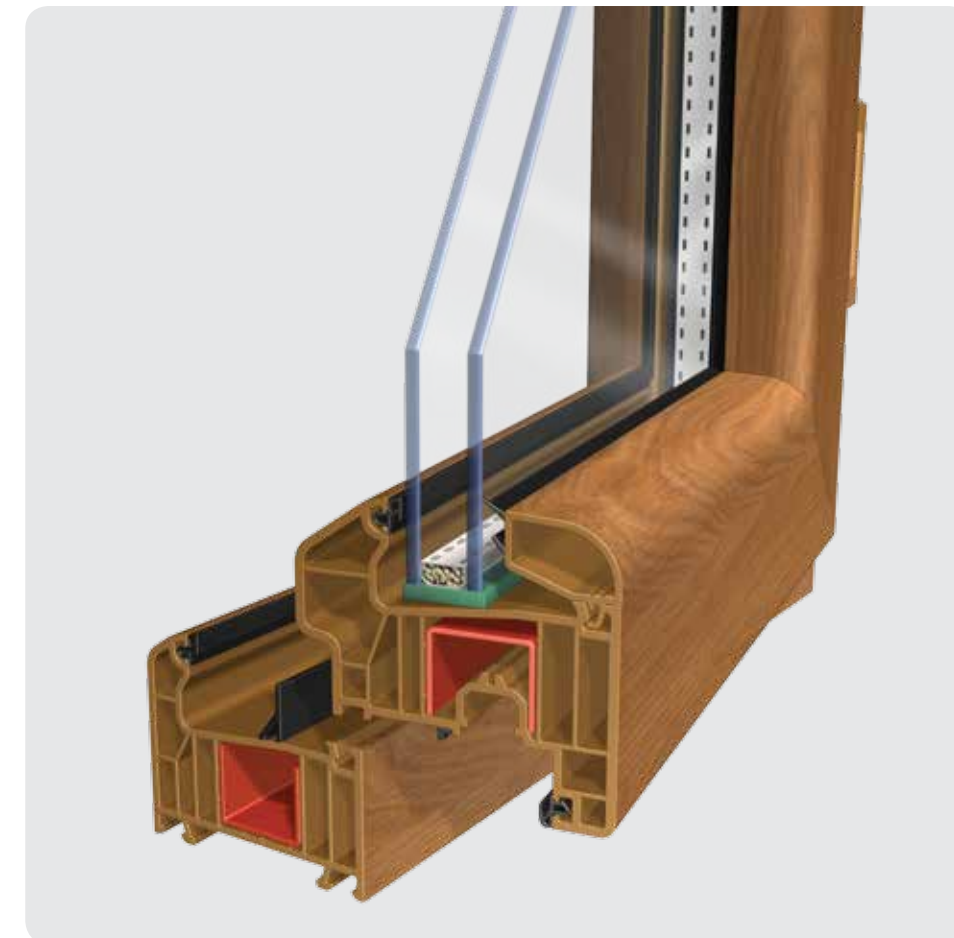
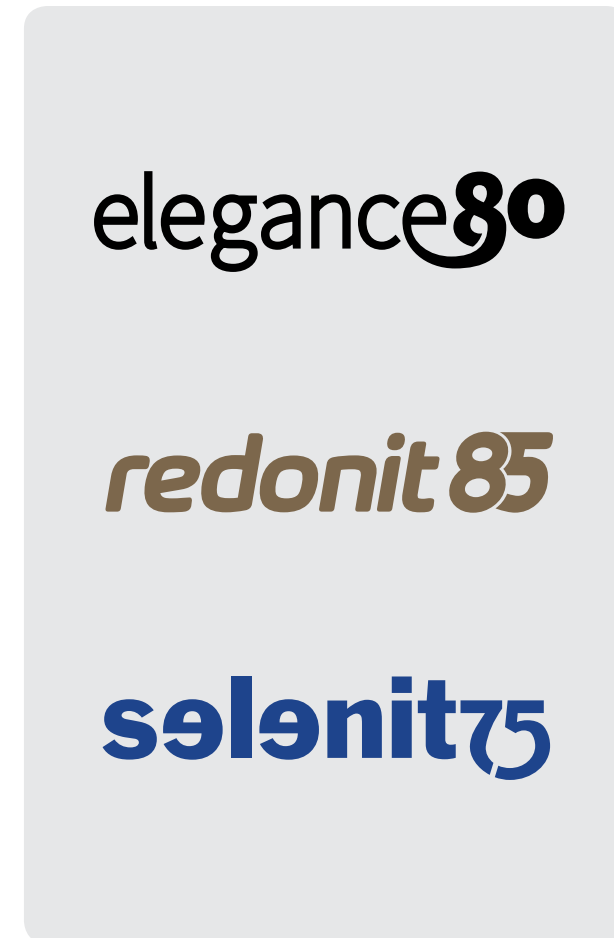

PVC PROFILE
DEALERS
TRAINING



Firat became "The First PVC Profile Producer That Provides Service By Certified Assembly Personnel In Turkey". Assembly personnel of the dealers of Firatpen, Winhouse and Gedizpen which are the PVC Door and Window System brands of Firat which is the most innovative and leader company in its sector; are now certified.

In accordance with the National Occupation Standards on PVC Joinery Assembly Staff published by the Occupational Competence Institute under Ministry of Labor and Social Security; via the accredited national and internationally valid certification activities from TÜRKAK, Firat aims for increasing the PVC window quality and energy saving, protecting brand values, minimizing the customer complaints arising out of assembly mistakes and minimizing the costs and increasing the power of its competency by enabling the assembly of the PVC Door and Window system to be carried out by experts.

Training is provided to the PVC Door-Window assembly personnel of the dealers of WINHOUSE in accordance with the 14UY0195-3 PCV Joinery Assembly Personnel National Occupational Standards in the FIRAT TRAINING INSTITUTE in the subjects such as occupational health and safety and environment.



OUR ENVIRONMENTAL POLICY



Making production by using “Environmental Friendly Production Technologies” since its foundation, FIRAT proves its sensitivity towards environmental health by the Environment Managing System established in 2002 and considers this field as a “Window of Management”. FIRAT, which obtained TS EN ISO 14001:2004 “Environment Managing System” certificate from SGS in 2003, thus had its sensitivity towards environmental health certified on the national and international platform.

FIRAT not only keeps the environmental consciousness it has put into practice within its own constitution but also transforms this consciousness into an environmental policy and shares it with its neighbors, suppliers and customers. Especially during the seminars it holds for its end-users at home and abroad, it shares primarily with its business partners the efforts it makes towards environmental problems and importance that should be given to the environmental health. 95% of the products of FIRAT consist of re-cycled (re-processable) materials. It sends its non-reprocessible and non-household products which are called wastes to the “Disposal Facilities” licensed by the Republic of Turkey, Ministry of Environment and Forests and perform the recycling process in these facilities.

The Environmental Management Programs and Projects for the Protection of Environmental Health drawn up by the Environmental Group formed by our environmental engineers are being realized within the constitution of FIRAT. FIRAT which is committed to comply with all the national and international Environmental Legislative Directives and Environmental Regulations fulfills all its legal liabilities and submits statutory assessment reports to the relevant Ministry. FIRAT, which is awarded by ISO (Istanbul Chamber of Industry) with the “Environment Incentive Reward” with its environmental Project drawn up in 2006, always gives priority to the importance of environmental health and shows the necessary sensitivity in all the investments it realizes.

We undertake to;

- Improve our environmental performance continuously by minimizing our wastes and increasing our efficiency,
- Comply with the national and local regulations regarding our activities and the directives of the European Union in regard to our products,
- Prevent pollution by eliminating it at its source,
- Evaluate environmental impacts as selection criteria during planning new investments,
- Increase the environmental awareness of our employees, customers, suppliers and dealers by informing them about our Environmental Management System.

ENVIRONMENTAL DECLARATIONS



One of the operations we carried out within scope of sustainability is the “Environmental Product Declaration” pertaining to the products we manufacture in 2015. Our company is currently the first and only firm in Turkey to have an Environmental Product Declaration for PVC Window and Door Profiles which are internationally approved in all markets and in compliance with European standards.

www.environdec.com/en/Detail/epd629#.VV2Zo_ntmko

EPDs are described through ISO 14025 to be documents which quantitatively assess and declare the environmental performance of a product according to predefined categories (raw material output, energy usage and efficiency, material and chemical substance content, emissions to air, water and soil and waste production) on the basis of parameters that are specified in ISO 14040 series. These declarations, which are based on the ecological footprint of economic activities and various emission and waste values that arise during the production process within scope of the Life Cycle Assessment (LCA) technique, are documents that are impartially certified by international experts and valid throughout the world. FIRAT is an international brand with the EPD documents it received within framework of sustainability and is the only company in Turkey within the sector to have its EPD documents registered in the ECO Platform in Europe. www.eco-platform.org/list-of-all-eco-epds.html

ECO Platform is an international institution which registers EPD documents that are issued by ECO Platform-approved organizations in Europe (Metsims; www.metsims.com), non-governmental organizations which represent the construction sector and LCA experts. The goal of ECO Platform is to ensure the development of construction products with certified environmental effect information, especially such as Type III EPD document. EPD documents that are registered in ECO Platform can be used both in Europe and at international level.

Climate Declarations

Another operation we undertook for the purpose of studying in our production processes the effects of global warming which has been very infamous recently and is known to lead to changes in the world’s climate system was the acquisition of “Climate Declarations”. FIRAT is the pioneer of its sector in this concern as well. Climate Declarations are documents that specify the carbon dioxide (CO2) equivalent of the amount of greenhouse gas emissions arising from the life cycle processes of a product. These documents are issued on the basis of the results of life cycle assessment studies which are performed as per ISO 14025. www.environdec.com/en/Detail/epd604#.VV2Zo_ntmko

**OUR
OCCUPATIONAL
HEALTH AND
SAFETY POLICY**

Firat has set up an Occupational Health and Safety System (OHSAS) that includes all of its activities and meets the requirements of OHSAS 18001 standard and has been executing it. It manages the matters which are considered as having a high OHSAS risk as a result of the danger definition and risk evaluation within this system.

- As FIRAT we undertake to;
- Improve the OHSAS performance continuously
 - Comply with the legal regulations regarding OHSAS
 - Evaluate the risks of OHSAS as criteria during the selection of new investments
 - Train employees regarding possible dangers which they may be exposed in order to improve OHSAS consciousness in our employees
 - Increase OHSAS consciousness of our customers, suppliers and dealers by informing them about OHSAS.



24

25



**INTEGRATED
PRODUCTION**

Making the PVC Windows and Doors to be hundred percent compatible with each other is only possible by producing them at the same facility, so Winhouse produces all of PVC Profiles, EPDM seals, TPE seals, Reinforcement steels, espagnolettes, window and door handles, mullion connectors and metal accessories all at its own plants in an integrated manner.

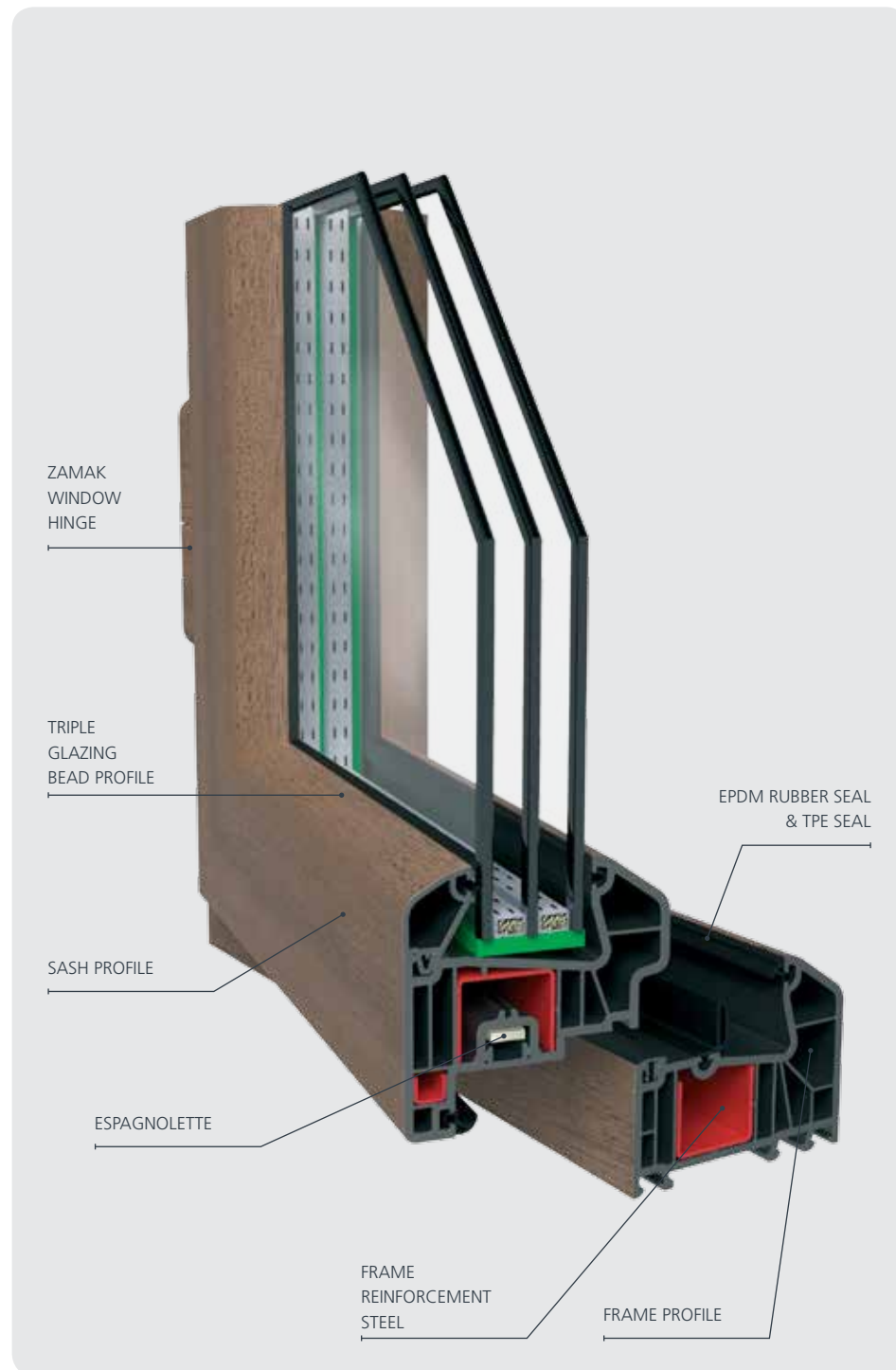
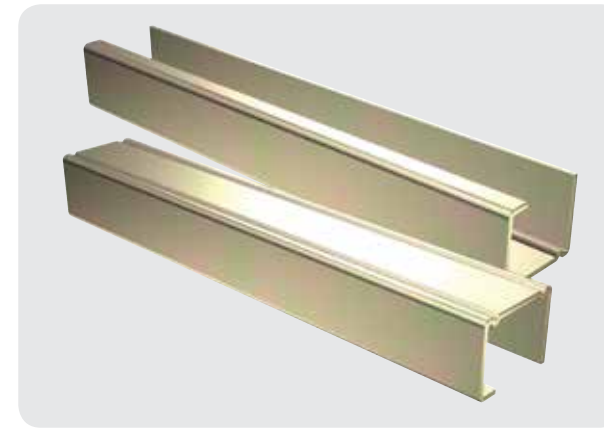

PROFILES

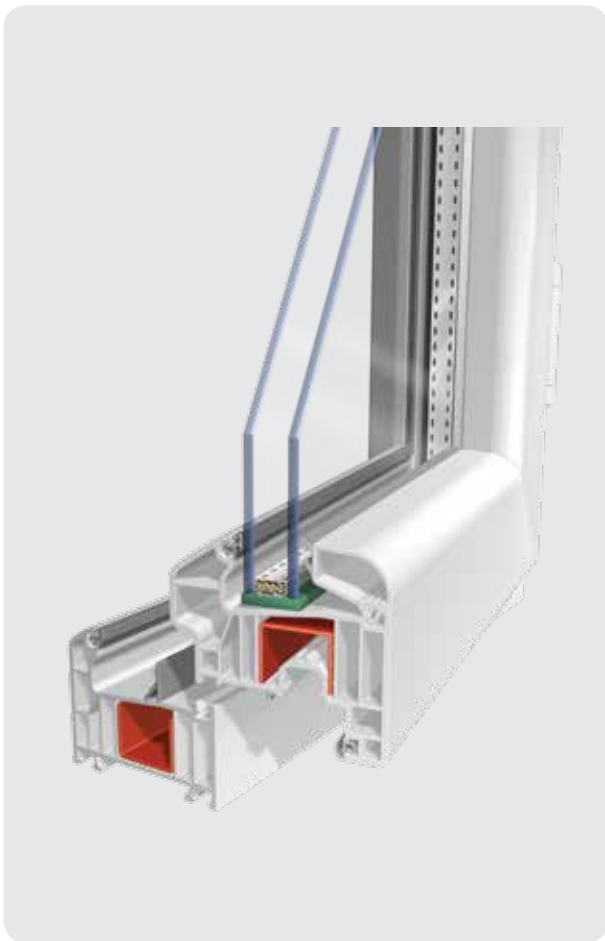

Winhouse controls all the processes from start to the latest stage in the production of PVC profile systems with the experience and knowledge it has and increases the quality of the product with its innovative capability.

All the processes of PVC window profiles from the input of raw materials to mould production, from the preparation of raw materials to production via extrusion are kept under control. While creating the necessary raw material mixture and formulation for the production of PVC profiles, the materials are tested against all raw material and final product tests are made, by taking the hard climate conditions into consideration.

Moulds are one of the most important criteria in producing high quality PVC profiles. Winhouse produces all of its moulds within its own facilities with the experience and knowledge accumulation it has and thus all the processes from the quality of steel to profile gravity could be kept under control. Full automatic raw materials feeding system used in Winhouse prevents dust entry to the environment and impurity entry into the raw materials from the environment. Winhouse, using the machines with the highest technology and quality, aims for the most effective and high quality production through the different types of machinery it uses depending on each profile section.

The profiles which form the main frame of window and door systems and carries out the main functions such as frame and sash. Since such profiles are the profiles affecting the final quality of the window, it is a necessity for the products to have all the national and international norms and to be produced in accordance with such quality standards. Design and geometry of the main profiles forming the system should be in a level which shall meet the minimum conditions required for the window. Visual aesthetics of these profiles are one of the most important factors which affect the visual aesthetics of the windows.

28

EPDM SEALS



Proper sound and heating insulation and functionality of PVC window and door systems are only possible through use of correct seals on the system.

WE USE EPDM RUBBER

We, as Winhouse, produce the most appropriate raw material among the synthetic rubbers, Ethylene Propylene Diene Monomer (EPDM) for our PVC door and window systems. EPDM seal is the only seal that has resistance to sunlight-air oxidation, ozone-induced cracking, shore hardness range of 30-95 at temperatures between +130 C -40 C and irreversible deformation values for sealing on the system under excessive wind load.

QUALITY AND SUSTAINABILITY

Another important aspect of EPDM seals is sustainability of quality. Thanks to our supply of invariable raw material, full-automatic production feeding systems, mixtures prepared by computer assistance and laboratories for conducting obligatory raw material and product test, Winhouse EPDM seals are always produced in the same quality and standards. We produce all our products containing sulphur and peroxide in accordance with the standards **GZ-716 / 1** and **TSE -7510**. Under these standards, density, hardness, elongation at break

and break strength and irreversible deformation of the seals are tested. We vulcanize EPDM seals in two ways, namely with sulphur and peroxide. Physical characteristics assured by means of vulcanization system by use of sulphur ensure that much less irreversible deformation is obtained at higher temperatures by vulcanization with peroxide.

MEASUREMENT AND CONTROLS

Diameter, wall thickness, ovalness and similar production measuring is performed by means of ultrasonic measuring equipment available on the production lines and thus improper production is prevented by activation of audio and illuminated warning systems in cases of off-standard situations. Additionally, the cross-section of the EPDM seals are magnified 10 times by use of our special projection equipment for constant performance measuring controls to the **accuracy of 0.001**. Manufactured in integration with PVC profiles, our seals are subject to measuring controls on samples taken from each package and are regularly archived.

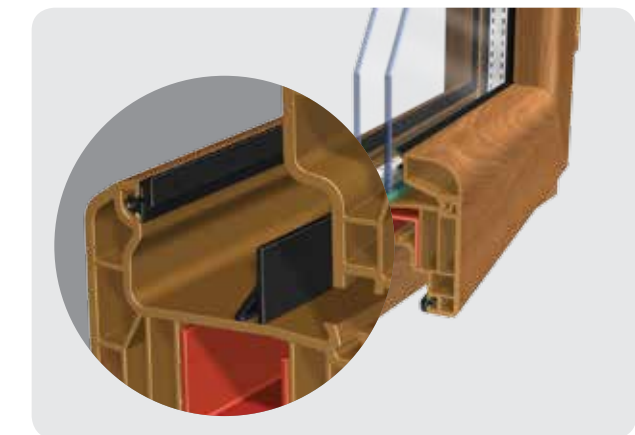

29

TPE SEALS



TPE (thermo plastic elastomer) seals are used in self-sealing profiles. These seals can be produced in every color. Winhouse applies grey and black TPE seals.

With the help of the exclusive plastic seal production technique developed by Winhouse, the company is able to manufacture TPE seals which come with a much higher performance than ordinary plastic seals. Winhouse grey seals consist of three layers and each of these layers is produced with different formula and raw materials; thus, they display the best performance values among plastic seals. The permanent deformation values are approximately 35 – 40 %. The active part of the seal (1st layer) is made of soft plastic while the middle section (2nd layer) is made of hard plastic and the vaulted cheeks which are installed within profiles are composed of PP (polypropylene).

Plastic seals which are installed to profiles tenaciously by mechanical solutions, ensure great convenience to the producer because of easy and secure welding with the profile in the source of thermofix and it can be fixed to the profile during the window production process because of the layers within. They meet the class values of EPDM rubber seals in the air permeability and wind pressure resistance performance tests for windows.

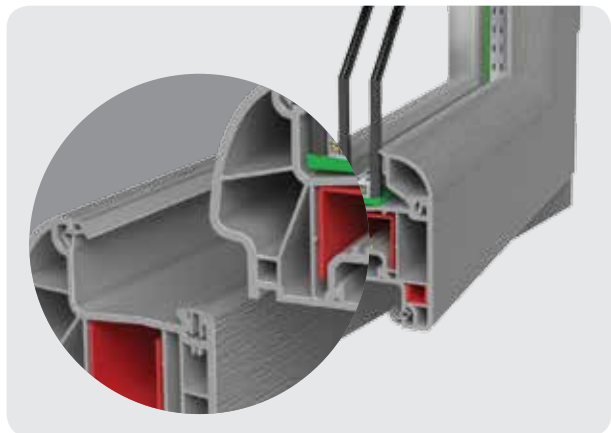

REINFORCEMENT STEELS



Reinforcement steel is one of the fundamental parts of PVC window and door systems, forming the bearing structure of the system and giving resistance to the plastic profile. On PVC window and door systems, the reinforcement steel ensures sound insulation, resistance to wind load, more powerful adherence of the systems with each other and of the hinges with the plastic profile, giving plastic profile its shape and ensuring it to maintain its structure for a long time. Winhouse reinforcement steels are manufactured in hot dipped galvanized class as per TSE 822 with zero defect and as integrated with our profiles thanks to the computer-aided control system present throughout all production stages including cutting, bending and packaging in accordance with FePO2g quality and DIN standards applicable for profile operations in accordance with TSE EN 10142. Hot dipped galvanized steels are subject to zinc coating test before production. Hot dipped galvanized steels have a long service life and have high resistance against corrosion. Its zinc coating does not come off even when shaped by bending. It is resistant against fire and all kinds of external effects. Loss of coating thickness is minimum under normal weather conditions. Quality control tests are continuously performed in our advanced laboratories throughout all the stages such as raw material, before, during and after production stages. Forming the framework of Winhouse PVC window

and door systems, the reinforcement steel maintains durability of the systems by keeping their integrity and shape for years.

GENERAL INFORMATION

Wall thickness of the reinforcement steel should be appropriate for the usage conditions of PVC window and door systems. For example, the reinforcement steels not having appropriate wall thickness in case of high buildings (+6 floors) fail to stand against wind load, causing the system to suffer damage, leading to air and water permeation in time. Structure and shape of the reinforcement steel should be very smooth. The reinforcement steels with deformed shape and structure cause deformation of the profile shape, leading to a functional damage of the structure of the system.

The gap between the reinforcement steel and the inner surface of the plastic profile should be minimum 1mm and maximum 2mm. If the gap is wider, then the resistance reduces, preventing proper screwing. If the gap is narrower, then it prevents the expansion of the plastic profile, causing cracking. Longitudinal cutting of the reinforcement steel should be adjusted by leaving proper melting distance at the welding points of the profile. Melting distance should be left at both directions, namely, 10 mm from the profile length in case of cuttings by 90° and 7.5mm in case of 45°. The reinforcement steel should definitely be used as a single piece in the opening where it is going to be used. When it is used as multi-pieces, it is going to damage the system. Reinforcement steel should be screwed down from at least two places even if it is used in the shortest longitude. Screw spacing should be 30-40 cm maximum. It should be screwed down at least 15 cm. maximum inside of the starting point, it should be cut carefully with the edges smooth and free of burrs, and the saw should be operated at low speed. The reinforcement steel should never be stored outdoors; there should be no rain, water, moisture or contact with floor in the storage area. There should be no excessive temperature differences in the storage area and long period storage should be avoided.



ACCESSORIES



Since the accessory is one of the most important elements forming the framework of the window, we offer our own brand Winhouse products to the customers as a result of our heavy R&D works on accessory and espagnolette group. Winhouse accessory systems are entirely developed by R&D department within Winhouse. After the product is designed and a prototype is made, it passed all the tests affecting the window performance such as resistance to wind load, water impermeability and air permeability. Winhouse products are subjected to the tests which will meet the requirements of the TSE and EN norms and deemed to be worthy of having national and international quality certificates.

- Our accessory and espagnolette systems include all of;
- Turn only
 - Tilt and turn
 - Sliding
 - Automatic Sliding
 - Pivot
 - Zenia Slide

systems. Winhouse espagnolette systems in different sizes for different window size and types are offered at Winhouse sales points with Winhouse guarantee.



Hinges

Our hinges are produced with the most appropriate and high quality materials in Winhouse production facilities. Zamak is the material with longest service period for overcoming the problems of hinges while carrying out their duties such as friction, being exposed to impact and load bearing.

Our hinges which are produced in Winhouse facilities and painted different colors depending on the profile color are in accordance with the TS EN 1935 standard. Our hinges have the service life of at least 25.000 opening and closing and we have two types of hinges which are 75mm and 90mm depending on the place of usage.

Handles

One of the elements which is commonly used, alluring the customer, increasing the value of the window is window and door handle. Winhouse offers plastic and aluminum window and door handles in different colors produced by Winhouse at their own sales points. Handles are produced in 3 main groups as handles, window handles, and locked door handles with different color options.

HEAT AND SOUND INSULATION

Sound Insulation

One of the most important factors affecting the comfort and health in our homes and workplaces is the noise pollution. Especially in big cities and areas with crowded traffic, sound insulation is very important. Windows have an important role in the exposure of buildings to outdoor environment. In accordance with the Regulation on Assessment of Environmental Sound, the maximum sound levels in the housing for the purpose of creating a healthy environment are given below

Area of Use	dB(A)	Time Frame
Bedrooms (inner city)	40	During night
Bedrooms (country)	35	During night
Living Rooms (inner city)	55	During the day and evening
Living Rooms (country)	40	During the day and evening
Living Rooms (suburbs)	45	During the day and evening
Kitchen (inner city, country, suburbs)	60	During the activity

These are the maximum levels of the ordinary sound intensity. It is possible to increase the quality of our living space by achieving lower values for such sound intensity.

You can find the sound intensity around you based on the location of your home from the table below;

Sound intensity (dB)	Number of vehicles per hour (vehicle/hour)	Distance to Road (m)	Class
50	10 - 50	> 35	1
51 - 55	10 - 50	25 - 35	2
56 - 60	10 - 200	25 - 35	3
61 - 65	1000 - 3000	100 - 300	4
66 - 70	1000 - 3000	30 - 100	5
> 70	3000 - 5000	> 100	6



The location of your home and sound levels of this place should be measured before the window assembly and type of window and glazing to be chosen for a healthy environment should be determined. With Winhouse Redonit, Elegance, Elegance Selective, Selenit 75, Selenit Selective, Selenit Selective Strong, Selenit Strong, Garnet 70, Garnet Selective Strong, Garnet Selective, Garnet Strong, Diamond, Opal 70, Andes & Andes Slide, Zenia Slide, Mono-Block Roller Blinds offers perfect sound insulation with appropriate glazing choice for your living spaces which are exposed to high level of outdoor sound.

Heat Insulation

The most important and expensive source in our country and in the world is energy. 75% of the energy which is largely imported from abroad is used in the homes for the purpose of heating. When buildings are designed insulation value is one of the most important performance criteria of each construction component. In buildings, the most critical points which separates the indoors from outdoors are windows. If the insulation values of the windows which we use in our homes are not appropriate, nearly 30% of the energy is lost to outdoors. Winhouse, knowing how important is this, has determined heat transfer coefficient value as the most important parameter while designing all the profile systems. While the profiles are being designed, their heat insulation values are calculated via simulations made in digital medium and profile size and number of chambers are designed in accordance with such values. PVC window systems offer the advantage of high insulation due to the advantage offered by its raw material when compared to its competitor aluminum and wooden windows. Up to three times better insulation can be achieved with a quality PVC window system. Due to this reason projects should be created and the windows should be subject to an engineering study just like the pvc profiles depending on the climate conditions of the area in which they are to be installed and type of glazing or even window sizes. Winhouse provides practical information about the works to be carried out in the trainings held in sales points and carries out inspections.



WIND LOAD RESISTANCE



$$W = C_f \cdot q \text{ (kN/m}^2\text{)}$$

W : Wind load value

C_f : Aerodynamic load coefficient (determining the wind coefficient depends on the geometry of the building and wind route.)

q: Suction speed pressure ($q = v^2 / 1600$)

V: Wind speed (m/sec)

There is an inertia created by the wind loads exposed by the buildings. The value of such inertia is calculated with the formula below.

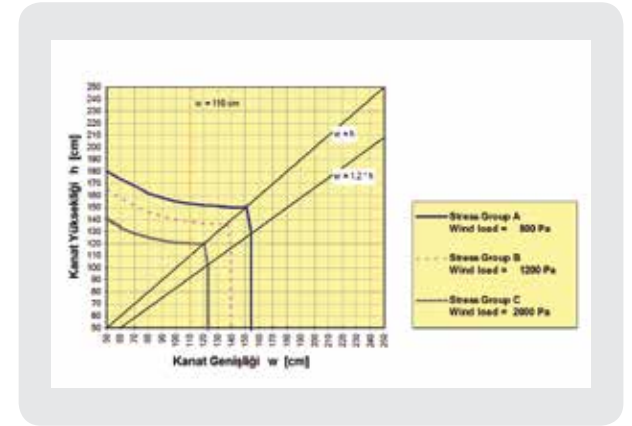

While calculating the wind load, required inertia momentum value calculated in the formula above should be provided by the window inertia momentum. Thus, the window could resist to the strength created by the wind load. While calculating the inertia value of the window, the inertia values of profile and reinforcement steel used should be calculated and required inertia value should be found. According to this calculation, thickness and structure of the reinforcement steel to be used should be determined. Window sizes and type of reinforcement steels to be used are determined with the calculations of average wind load in the area and inertia.

Buildings are constantly exposed to some loads due to physical and climate conditions. One of the most important among such loads is the wind load which affects windows. Wind load ranges as below depending on the height and type of structure:

Elevation From The Ground (m)	Wind Speed (m/s)	General Building Wind Load Value (Pa)	Tower Building Wind Load Value (Pa)
0 - 8	28	600	800
9 -20	36	960	1.280
21 -100	42	1.320	1.760
> 100	46	1.560	2.080

* For a building to be a tower, its height should be at least 5 times of the average building width.

* Wind load values are calculated by multiplying the table values which are inclined towards the wind route with angle "x" and Sinx values.

The wind load exposed by the windows is determined as below in accordance with the TS 498 standard.



AS THE FLOOR NUMBER INCREASES, THE WINDLOAD ON THE WINDOWS INCREASES AS WELL



**PERSPIRATION
AND PVC
WINDOW
USAGE**

PERSPIRATION

The incident which is called "humidity" colloquially is actually the water in the form of vapor in the air. There is always some water vapor in the air of the environment we are in. The ratio of the water vapor amount contained in the air to the amount of maximum water to be carried by the air at the same temperature is called relative humidity. Maximum amount of water to be stored by the air in 1 cubic meter area is 17,5 gr. If there is 10gr water vapor in the air of such an environment, the humidity ratio is determined as 57% $[(10/17,5) \times 100 = 57]$. Water vapor in the air has a certain condensation temperature. When the air is in contact with surfaces colder than the environment, if the surface temperature is lower than the perspiration temperature, the state of water vapor in the air changes to liquid. This is called perspiration. Minimum values for no perspiration to occur on the surface temperatures depending on the humidity rate and environment temperature are given in the table below.

**Temperature Humidity
(°C) Ratio**

	30%	35%	40%	45%	50%	55%	60%	65%
30	10,5	12,9	14,9	16,8	18,4	20	21,4	22,7
29	9,7	12	14	15,9	17,5	19	20,4	21,7
28	8,8	11,1	13,1	15	16,6	18,1	19,5	20,8
27	8	10,2	12,2	14,1	15,7	17,2	18,6	19,9
26	7,1	9,4	11,4	13,2	14,8	16,3	17,6	18,9
25	6,2	8,5	10,5	12,2	13,9	15,3	16,7	18
24	5,4	7,6	9,6	11,3	12,9	14,4	15,8	17
23	4,5	6,7	8,7	10,4	12	13,5	14,8	16,1
22	3,6	5,9	7,8	9,5	11,1	12,5	13,9	15,1
21	2,8	5	6,9	8,6	10,2	11,6	12,9	14,2
20	1,9	4,1	6	7,7	9,3	10,7	12	13,2
19	1	3,2	5,1	6,8	8,3	9,8	11,1	12,3
18	0,2	2,3	4,2	5,9	7,4	8,8	10,1	11,3

On the assumption that room temperature is 23 °C and humidity ratio is 45% in the table above, for the perspiration to occur at any surface, temperature of that surface should be lower than 10,4 °C and below. Due to this reason, for the perspiration to be prevented, increasing the indoor temperature levels is one of the most effective methods. This can be achieved by insulating the walls from outside and using glasses with low heat transfer coefficient.

Perspiration may be prevented with the methods below;
 → Increasing the indoor surface temperature of the building with insulation. (20–22 °C)
 → In order to decrease the humidity ratio of indoors, it should be aired for at least 3 times each for 15 minutes by opening the sash with the help of turn and tilt system.



→ Preventing the humidity from reaching other rooms by closing the doors of internal humidity sources (such as laundry drier, bathroom and kitchen).
 → Not using the heaters such as Gas stove, catalytic which produce water vapors.

MAINTENANCE OF WINDOWS

PVC window systems are the window systems which can have the longest service life with the least amount of maintenance amongst its competitors. In order to sturdily use these systems for a long time, some basic and simple points should be observed. Some of these points are given below;

→ For a longer service life, it is important to oil the espagnolettes, which are the mechanisms constantly working since they are made of metal and they constantly move, in every 6 months.
 → Profiles should be cleaned with warm water, powder detergent should not be used so that surface wear should not occur, and cleaning should not be carried out via surface wearing materials such as sponge, sandpaper.
 → Materials such as thinner which could harm the surface and cause the material to lose its composure should not be used in the window surface cleaning.
 → Protective labels applied on the profile surfaces are used for the purpose of protecting the profiles from the impacts which might occur during transportation or assembly. Protective labels should be removed after the assembly. If the labels are not removed for a long time, it would be harder to remove the labels which have been exposed to the sun for a long time. Protective labels should be removed in maximum 3 months after the assembly.
 → Materials such as paint, mortar which could be formed on the profile in construction environment should be immediately cleaned and hard objects and chemicals like thinner should not be used for cleaning them.
 → The labels on the glasses which are assembled into the windows after the first assembly should not be removed with hard objects, they should be removed with the help of a cloth dampened by warm water and after the label is softened via hot water.

**PENESKOP
TECHNOLOGY**



**LAMINATED
WINDOWS**



Heat losses in the buildings occur in the following amounts: 40% from outer walls, 30% from the windows, 17% from the roof and 6% from the flooring.

When we think that we procure 75% of our energy from abroad, the heat losses become more important by means of efficient usage of energy. In order to prevent the heat losses occurring in the windows requires a sort of window engineering. Criteria such as correct series, correct glass, location of the house and geographical location may prevent heat losses from windows up to 80%. Winhouse started the PENESKOP application from the January 2015 for the purpose of making a positive contribution to the economy of the country with the effective usage of the energy sources for which we are largely foreign-dependent.

Winhouse offers appropriate solutions by measuring the heat losses in the aluminum, wood and old pvc windows via thermal cameras and prefers FLIR Thermal Camera Systems in such applications and shares these cameras with a certain number of sales points. Winhouse which started the certified assembly training for the first time in the sector in order to minimize the heat losses to be occurred especially in the exchange market, to decrease the negative customer feedback ratio and to protect the brand value, identified PENESKOP in detail in such trainings and completed the point of sale training accompanied with PENESKOP. Our sales points which determine the most appropriate Winhouse pvc solutions for your home via a free exploration, decreases the amount in your fuel bills.

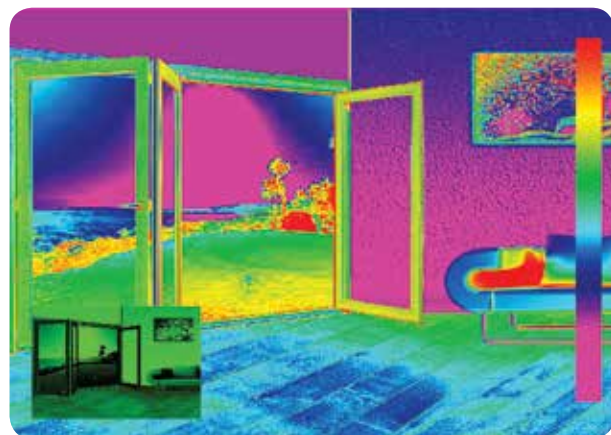

Covered by using of hot-melt lamination technique Winhouse PVC Window and Door Systems having natural wood pattern provide ideal solutions for your original architectural and special decoration expectations with their wide choice of coating, aesthetic look and functionality. To satisfy our customers' high expectations regarding their projects and decoration alternatives, we have added eyecatching collection of new colors to our existing laminated options of Golden Oak, Oak, Mahogany, Cedar, Walnut, Grey and Anthracite laminated patterns. You now have more color options for your projects and homes with our new color options: Anteak, White, Aluminium Brush Effect, Winchester, Cream White, Silver Brush Effect, Steel Blue, Dark Green, Ash, Dark Oak, Silver Grey, Macoré, Trompet and Eiche Rustical. You can contact sales points in order to see color options. The series develop different alternatives that are compatible with your furniture, wall color and the outer facade of the buildings.



LAMINATED LABELS, PROFILE COLOR AND SEAL COLOR

No	Label Color	Profile Color	Seal Color
1	Golden Oak	Brown	Black
2	Oak	Brown	Black
3	Mahogany	Brown	Black
4	Cedar	Brown	Black
5	Walnut	Brown	Black
6	Macore	Brown	Black
7	Dark Oak	Brown	Black
8	Eiche Rustical	Brown	Black
9	Winchester	Brown	Black
10	Silver Brush Effect	Grey	Grey
11	Silver Grey	Grey	Grey
12	Aluminium Brush Effect	Grey	Grey
13	Grey	Grey	Grey
14	Ash	Dark Grey	Black
15	Anthracite	Dark Grey	Black
16	Trompet	Dark Grey	Black
17	Dark Green	Dark Grey	Black
18	Steel Blue	Dark Grey	Black
19	Anteak	Dark Grey	Black
20	White	White	Grey
21	Cream White	White	Grey

COLOR CHART



42

43



SERIES

Our cities are changing with the effect of the changes in construction technology and sociological changes. The architects prefer the brand which can solve the details to make their dreams come true. The answers only to aesthetical concerns do not make us preferred. The city life requires more heat and noise insulation and more comfort in lives. Winhouse meets the requirements of all projects. Redonit 85, Elegance 80, Elegance Selective, Selenit 75, Selenit Selective, Selenit Selective Strong, Selenit Strong, Garnet 70, Garnet Selective Strong, Garnet Selective, Garnet Strong, Diamond 60, Opal 70, Andes & Andes Slide, Zenia Slide, Roller Blinds and Shutter Systems bring artistic touches to your house with different color options and brings futuristic window technologies to your house with its rich auxiliary and detailed profiles.



WORLD'S
SHINING
STAR

DIAMOND 60



SYSTEM

- The system has a profile width of 60 mm.
- It is designed to have 4 chambers.
- In the system, it is possible to use glass units of 5mm, 20mm and 24mm.
- DIAMOND 60 series meet all requirements in wind load resistance, water and air impermeability parameters by means of its profile width, number of chambers, reinforcement steel instruments and impermeability system.
- With oval glazing bead profiles, it brings the smooth features of the exterior into the interior as well.
- The system is compatible with 13 axis espagnolettes.
- It was designed to conveniently provide solutions for all architectural technicalities through its detailed and auxiliary profiles.

WIND LOAD RESISTANCE

- DIAMOND 60 systems successfully passed safety test of 2.000 Pa (1655 km/h) wind load resistance.
- While designing DIAMOND 60 system's reinforcement steel and its locations inside the profiles, the maximum wind load values to which the buildings can be exposed were taken into consideration.
- The system easily meets the resistance value requirements for covering the wide openings via its detailed and grillage profiles.

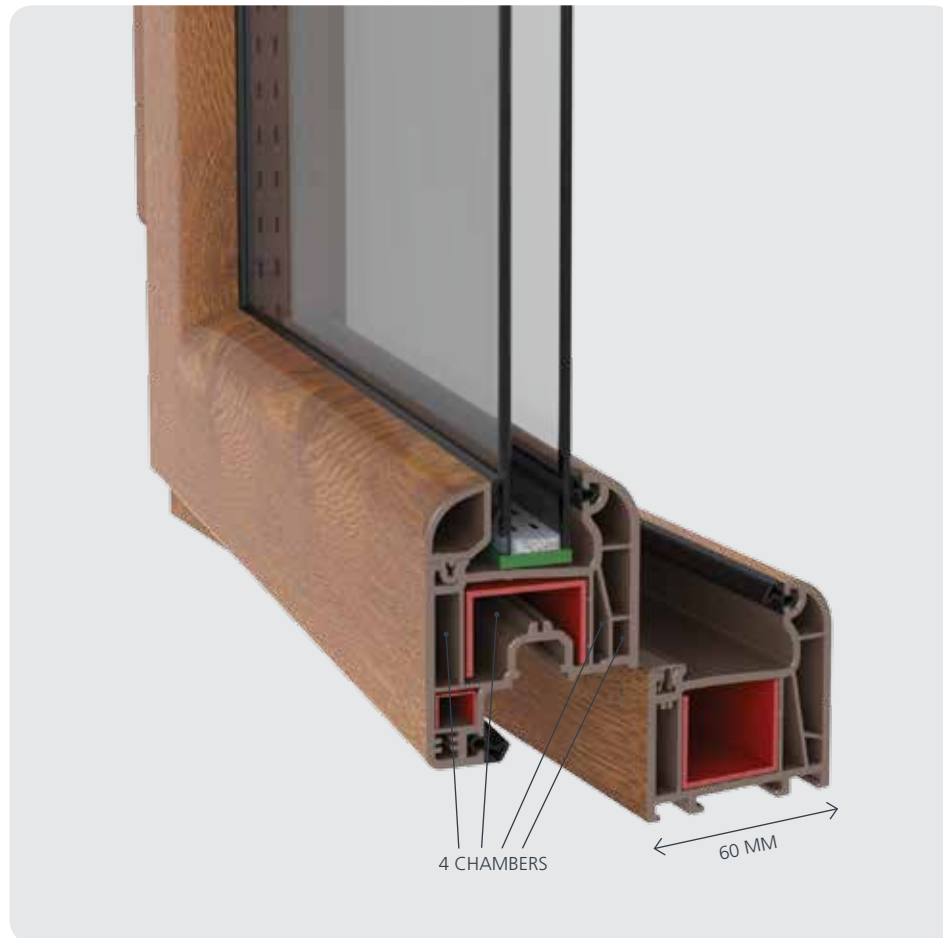

4 CHAMBERS

60 MM

FRAME & SASH WIDTH 60 MM



AESTHETICS

DIAMOND 60 series create an aesthetic integrity thanks to their oval contours present in all profiles and, by means of their specially designed profile, they become prominent for structures where a wider view of the scenery is demanded when compared with the other 60 series. The series enrich the aesthetic appearance through different lamination color and pattern options.

diamond60

NEW ERA ON 60 SERIES

Our lives are being moved to new places. Our rising sense of quality, aesthetic values and sense for comfort makes us more selective. We don't want to spare time and sources to the temporary solutions; we prefer smooth and highly economic life choices. Justifiably, we would like to have quality, aesthetics, performance values, comfort, decorative expectations and long-lasting economic systems in the same product. DIAMOND meets all of yours expectations and starts a new era for windows produced in 60 series.

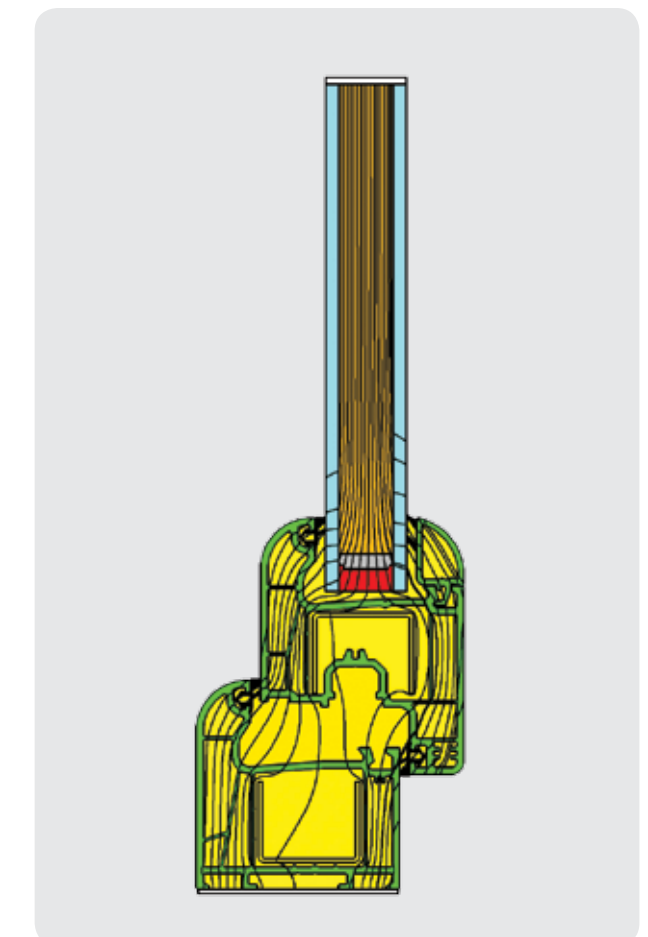

WINDOW HEAT FLOW DIAGRAM UF:1,46 W/M² °K UW: 1,63 W/M² °K

WATER AND AIR IMPERMEABILITY

→ Thanks to the water drainage channels and sets designed to discharge the rainwater faster and in an easier way, the high resistance to water even at high wind loads was provided.

→ Under tests carried out with 600 Pa (110 km/h) wind load and 4 liters of rainwater per minute, the system did not leak any water inside and proved its high quality.

HEAT INSULATION

→ By means of the chamber numbers, chamber widths and profile heights developed in consideration of the profile width, DIAMOND 60 system is able to meet all the requirements regarding the thermal conductivity coefficient.

→ In accordance with the TS EN ISO 10077-2 standard, the window system with the dimensions of 1,23 m x 1,43 m has achieved the values of $U_w: 1,46 \text{ W/m}^2 \text{ °K}$ and $U_f: 1,63 \text{ W/m}^2 \text{ °K}$.

SOUND INSULATION

→ DIAMOND 60 Series provides sound insulation with values up to 38 dB. Therefore, it is possible to create a sound environment at a high quality life level even at the loudest places.

→ The sound insulation level to be acquired via acoustic glasses that can be used with the system isolates the noise of outdoors from indoors in the most efficient way.

DIAMOND 60 SERIES MAIN & AUXILIARY PROFILES

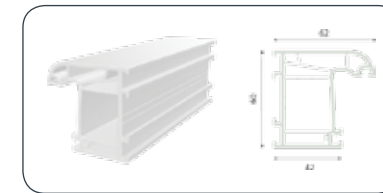
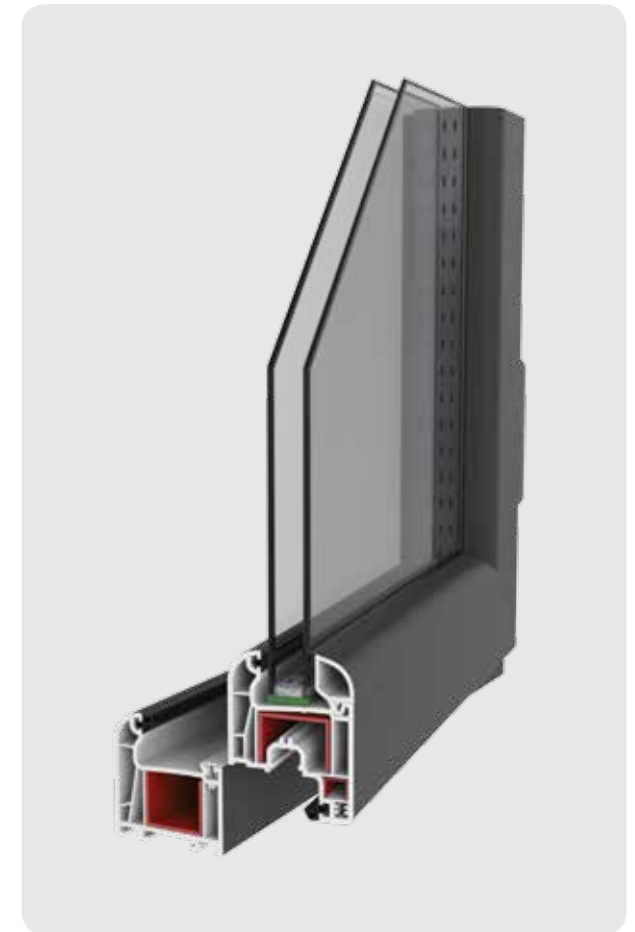

FRAME PROFILE

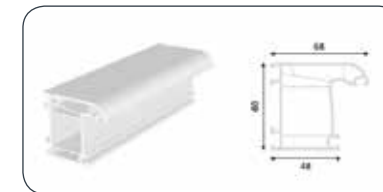

WIDE FRAME PROFILE

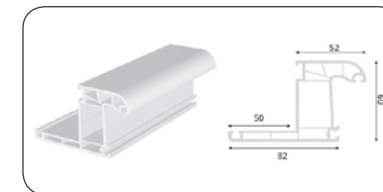

WIDE LINING FRAME

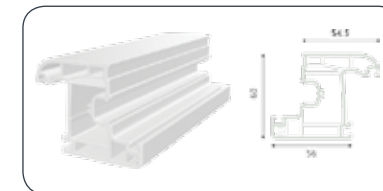

SASH PROFILE



SASH ADAPTING PROFILE

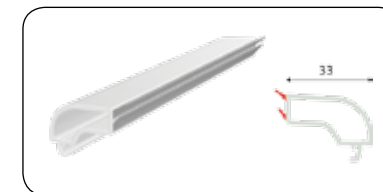

SINGLE GLAZING BEAD PROFILE (5 MM)

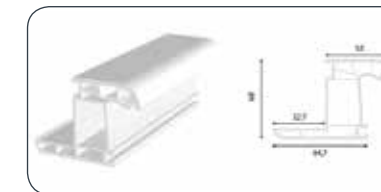

LINING FRAME PROFILE

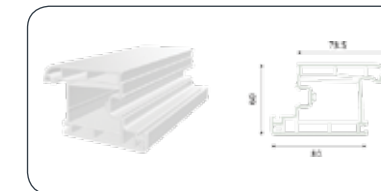

INSIDE OPENING DOOR PROFILE

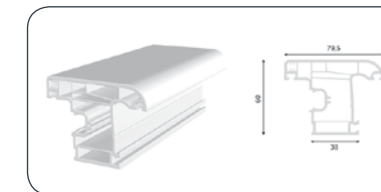

OUTSIDE OPENING SASH PROFILE

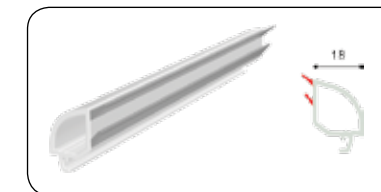

DOUBLE GLAZING BEAD PROFILE (20 MM)

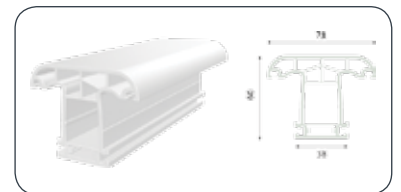

MULLION PROFILE

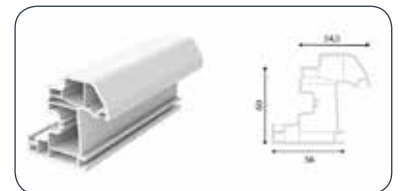

DRAINED SASH PROFILE

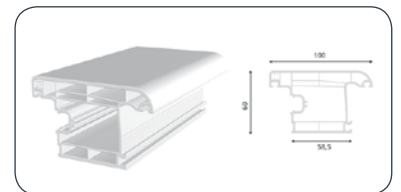

OUTSIDE OPENING DOOR PROFILE

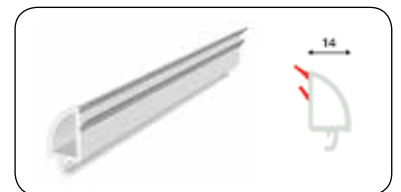

DOUBLE GLAZING BEAD PROFILE (24 MM)



PROFILE WIDTH
60 mm

NUMBER OF CHAMBERS
4

PROFILE HEAT INSULATION
1,46 W/m² °K

WINDOW HEAT INSULATION
1,63 W/m² °K

SOUND INSULATION
38 db

AIR PERMEABILITY CLASS
4

WATER IMPERMEABILITY CLASS
9A

WIND LOAD RESISTANCE CLASS
C3

GLASS THICKNESS
5, 20, 24, 32 MM

The calculations were made by using a glass unit with a thermal conductivity coefficient of for a window with dimensions of **1,23x1,43 m** in accordance with the standard **TS EN ISO 10077-2**.

GARNET
&
GARNET
SELECTIVE



GARNET TILT AND TURN WINDOWS

insulation in modern structures. The series develop different alternatives that are compatible with your furniture and wall color and the outer façade of the buildings.

SYSTEM

- Garnet and Garnet Selective systems, which provide esthetical integrity thanks to the Oval Drained Sash profile, have two different drained sash profiles options. Oval drained sash profile has the same ovality with the frame; and another drained sash profile is with sharper edges, these are also offered with Garnet system, depending on the customer's demand.
- All main profiles of Garnet and Garnet Selective series have a width of 70 mm.
- Garnet Selective has Class A wall thickness; Garnet has Class B wall thickness.
- While the system has 4 different types of oval shaped glazing beads which increase the interior width, it also offers 4 different decorative glazing bead profile alternatives.
- It can solve all the architectural details thanks to its detailed and auxiliary profiles designed compatible with its main profiles.
- Glass application until 40 mm can be done thanks to the system's glazing bead profiles.
- Garnet and Garnet Selective series provide you options to meet decorative expectations and add value to your house with different laminated color applications.

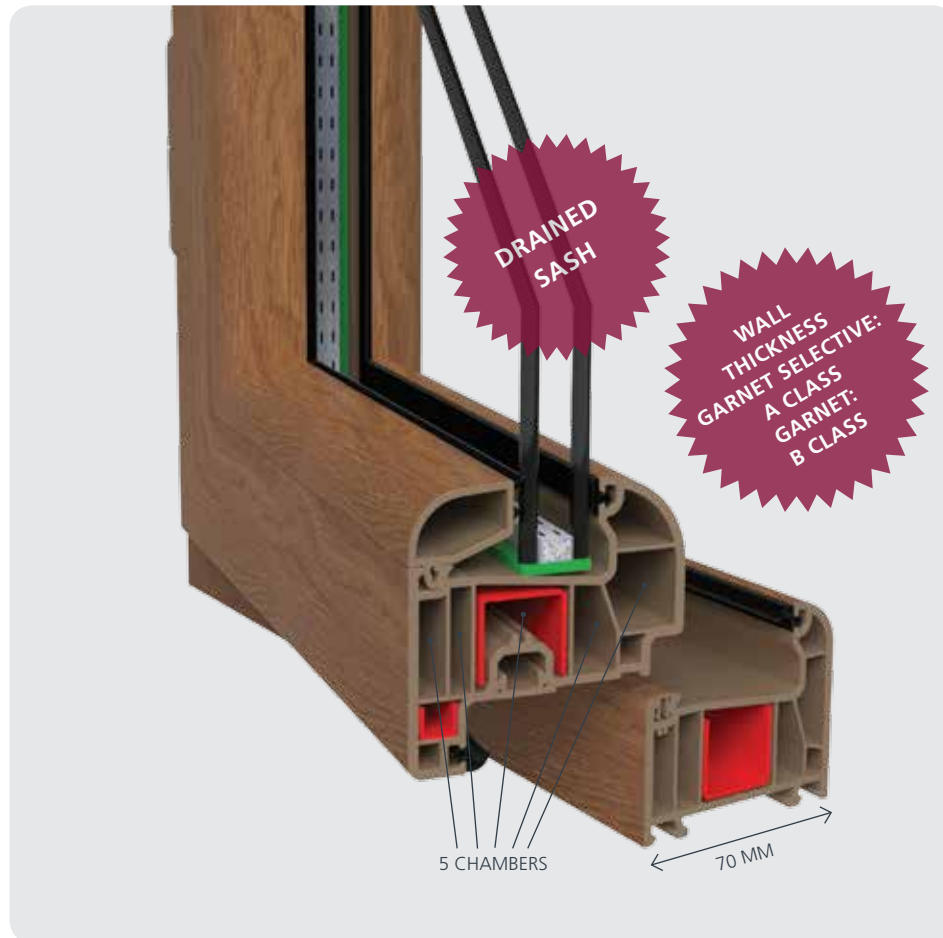

FRAME & SASH WIDTH 70 MM



Garnet70
Garnet70
Selective

NEW ERA IN SERIES OF 70MM WIDTH
GARNET 70 & GARNET SELECTIVE

Today's city culture and structural technologies are shaped at totally new dimensions. Cities are full of differentiating silhouettes caused by this change. New living areas make aesthetics, isolation, comfort, and efficiency principles come forward. Following closely this change, we fulfil the need of the differentiating construction technologies with a new series. Garnet Selective with Class A wall thickness and Garnet, both of which interpret the 70 mm series with a different aesthetics and isolation perspective, are the new choices of the modern structures.

ABOVE-STANDARD SOLUTIONS WITH 70 MM SERIES
Garnet and Garnet Selective Series, which were designed to bring a new dimension to the quality and aesthetical understanding of the window standard, increase the comfort in your living areas with the excellent heat and sound insulation. Garnet, whose all profiles have got 70 mm width and 5 chambered design together with Garnet Selective which has Class A wall thickness, are the new choices of architecture. Garnet and Garnet Selective fulfil the expectations of the new trends with different color options and start a new era in 70mm series of windows providing excellent heat and sound

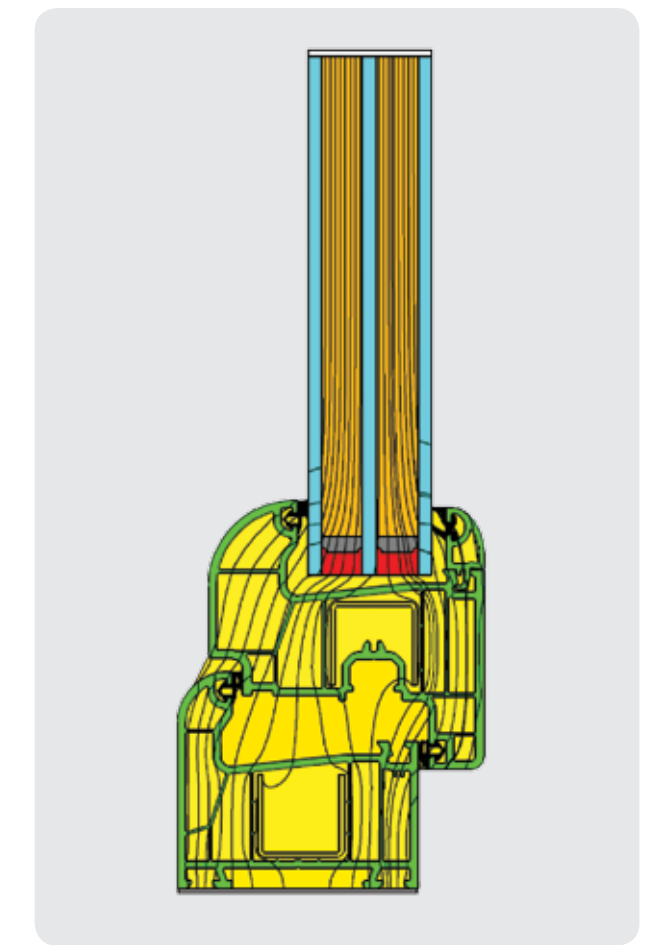

WINDOW HEAT FLOW DIAGRAM UF: 1,2 W/M² °K UW: 1,05 W/M² °K

WIND LOAD RESISTANCE

→ Garnet system is designed pursuant to 3.000 Pa (245 km/h) safety test on wind load and 600 Pa (110 km/h) water impermeability strength test and it has successfully passed these tests.

→ The Garnet Selective Series, which has Class A wall thickness for providing resistance in high wind load structures, offers perfect solutions.

→ While developing Garnet system, the maximum wind load values to which the buildings can be exposed were taken into the consideration; the structure of the reinforcement steel and their locations inside the profiles were designed in the most effective way.

→ System, whose detailed and box profiles provide solutions to meet the architectural needs, easily ensures the closure of the wide openings and necessary resistance values.

WATER AND AIR IMPERMEABILITY

→ Garnet and Garnet Selective series provide high resistance to water even at high wind loads, thanks to its water drainage channels and sets designed to discharge the rainwater in a faster and easier way.

→ The system did not let any water inside and proved its high quality under the tests carried out with 600 Pa (110 km/h) wind load and 4 liters of rainwater per minute.

HEAT INSULATION

→ The profile designs of the Garnet Series were made as for the thermal conductivity coefficient values which is the most important part of energy conservation, to be at minimum levels.

→ Profile width, chamber numbers and chamber width of the system were created to keep the heat and sound insulation at maximum levels.

→ All profiles of Garnet and Garnet Selective system have a structure of 5 chambers and since the chamber width is large, low level coefficient of thermal conductivity values are provided.

→ Compatible with TS EN ISO 10077-2 standards, Ug: 0.7 W/m²K, Uw: 1,05 W/m²K, and Uf: 1.2 W/m²K values were accomplished with the windows system which has a size of 1,23m x 1,43m.

SOUND INSULATION

→ One of the most important criteria in window systems is the sound insulation. High sound levels about 70dB in the areas close to airports, railways or crowded highways are decreased to values under 30 dB at which a child can sleep easily.

→ Sound insulation up to 40 dB value can be provided with Garnet and Garnet Selective series. Therefore, it is possible to create a sound environment at a high quality life level even at the loudest places.



PROFILE WIDTH
70 mm

WALL THICKNESS
GARNET SELECTIVE **A CLASS**
GARNET **B CLASS**

NUMBER OF THE CHAMBERS
5 pcs

AIR PERMEABILITY CLASS
4

WATER IMPERMEABILITY CLASS
9A

WIND LOAD RESISTANCE CLASS
C3

SOUND INSULATION
40 db

PROFILE HEAT INSULATION
1,2 W/m² °K

WINDOW HEAT INSULATION
1,05 W/m² °K

GLASS THICKNESS
5, 20, 24, 32, 40 MM

The calculations were made by using a glass unit with a thermal conductivity coefficient of **0,7 W/m² °K** for a window with dimensions of **1,23x1,43 m** in accordance with the standard **TS EN ISO 10077-2**.

52

53

GARNET 70 SERIES MAIN & AUXILIARY PROFILES

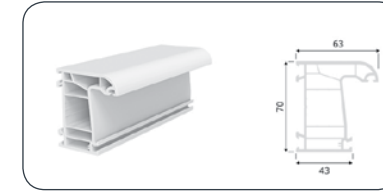

FRAME PROFILE

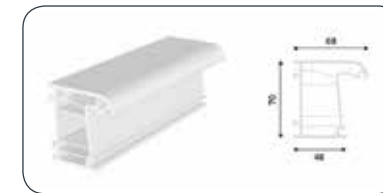

WIDE FRAME PROFILE

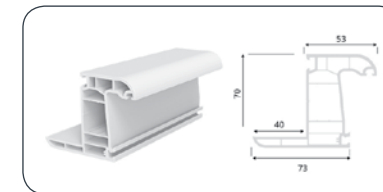

LINING FRAME PROFILE

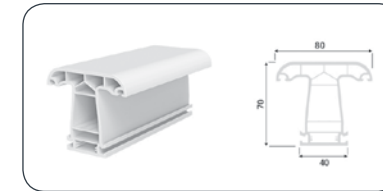

MULLION PROFILE

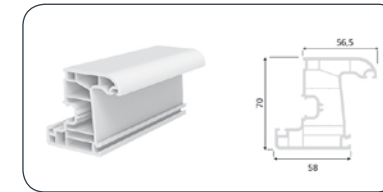

SASH PROFILE

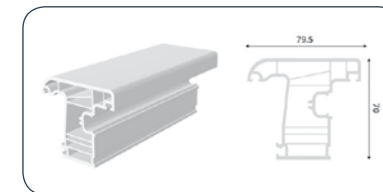

OUTSIDE OPENING SASH PROFILE

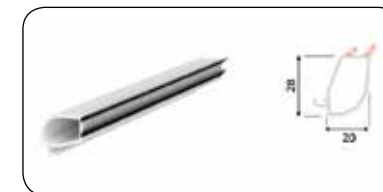

DOUBLE GLAZING BEAD PROFILE (20 MM)



35 MM LINING FRAME PROFILE

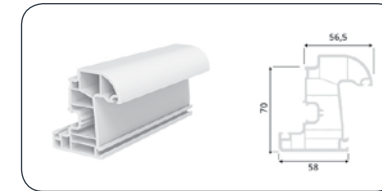

OVAL DRAINED SASH PROFILE

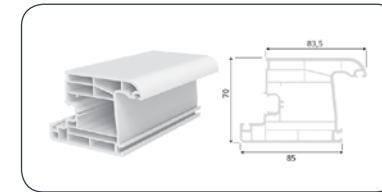

INSIDE OPENING DOOR PROFILE

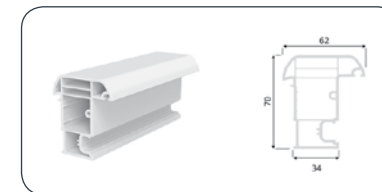

SASH ADAPTING PROFILE

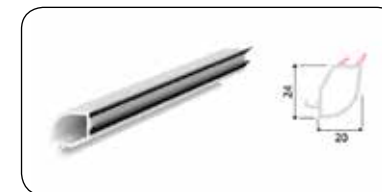

DOUBLE GLAZING BEAD PROFILE (24 MM)

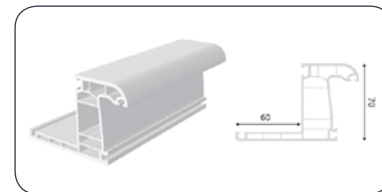

WIDE LINING FRAME PROFILE

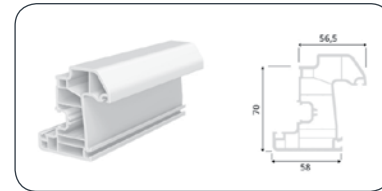

DRAINED SASH PROFILE

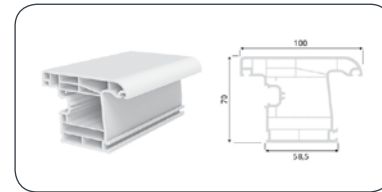

OUTSIDE OPENING DOOR PROFILE

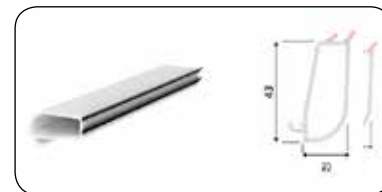

SINGLE GLAZING BEAD PROFILE (5 MM)

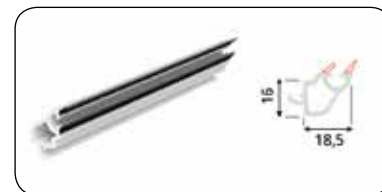

TRIPLE GLAZING BEAD PROFILE (32 MM)

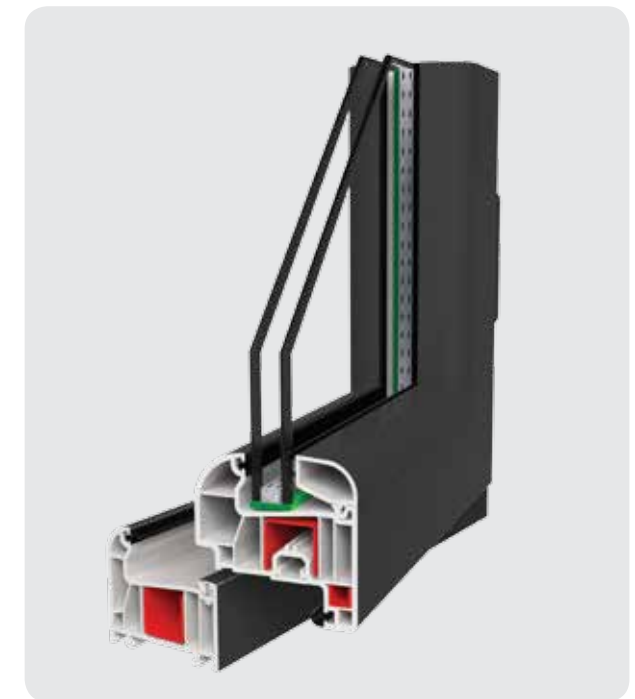

GARNET
STRONG
&
GARNET
SELECTIVE
STRONG



GARNET SELECTIVE STRONG TILT AND TURN WINDOWS

with different color options and start a new era in the 70mm series of windows providing excellent heat and sound insulation in the modern structures. The series develop different alternatives that are compatible with your furniture and wall color and the outer façade of the buildings.

SYSTEM

- Garnet Selective Strong and Garnet Strong systems, which provide esthetical integrity thanks to the Oval Drained Sash profile, have two different drained sash profiles options. Oval drained sash profile has the same ovality with the frame; and another drained sash profile is with sharper edges, these are also offered with Garnet system, depending on the customers demand.
- All main profiles of Garnet Selective Strong and Garnet Strong series have a width of 70 mm.
- Garnet Selective Strong has Class A wall thickness and triple sealing system; Garnet Strong has Class B wall thickness and triple sealing system.
- While the system has 4 different types of oval shaped glazing beads which increase the interior width, it also offers 4 different decorative glazing bead profile alternatives.
- It can solve all the architectural details thanks to its detailed and auxiliary profiles designed compatible with its main profiles.
- Glass application until 40 mm can be done thanks to the system's glazing bead profiles.
- With different laminated color applications,

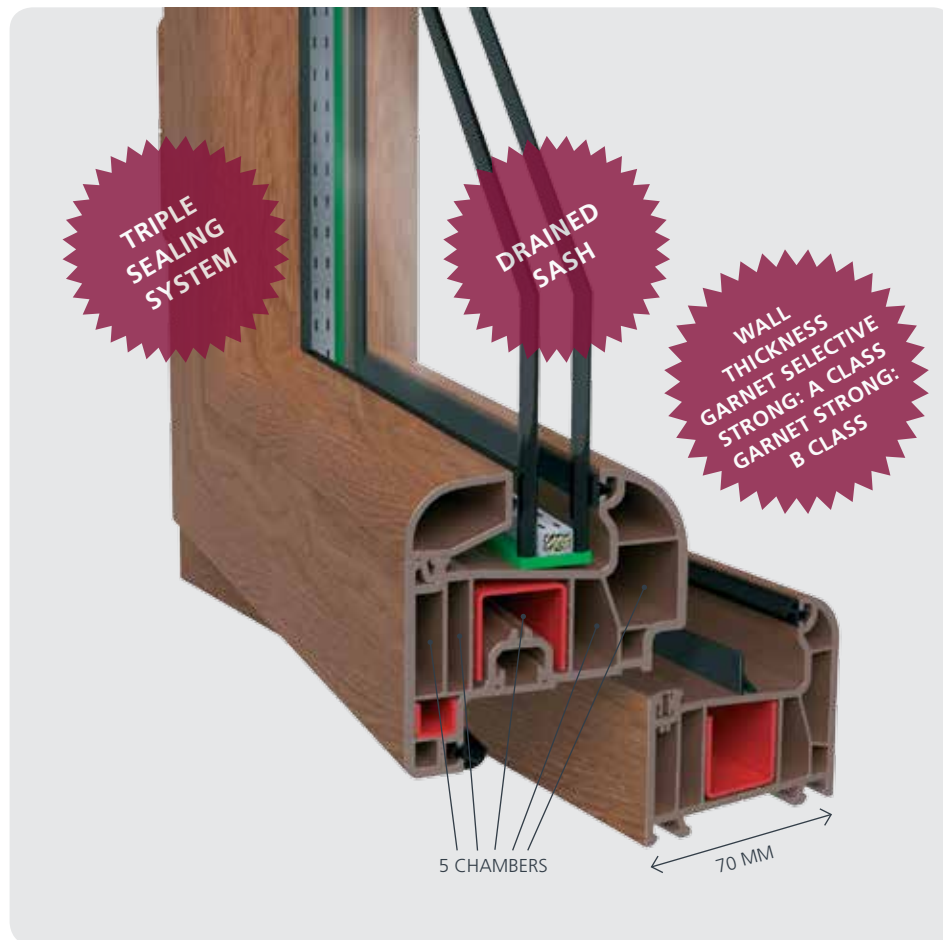

FRAME & SASH WIDTH 70 MM



Garnet70
— Strong —
Garnet70
— Selective Strong —

NEW ERA IN SERIES OF 70MM WIDTH
GARNET SELECTIVE STRONG & GARNET STRONG
Today's city culture and structural technologies are shaped at totally new dimensions. Cities are full of differentiating silhouettes caused by this change. New living areas make aesthetics, isolation, comfort, and efficiency principles to come forward. Following closely this change, we fulfil the need of the differentiating construction technologies with a new series. Garnet Selective Strong with Class A wall thickness and Garnet Strong, both of which interpret the 70 mm series with triple sealing system and a different aesthetics and isolation perspective, are the new choice of the modern structures.

ABOVE-STANDARD SOLUTIONS WITH 70 MM SERIES
Garnet Selective Strong and Garnet Strong Series, which were designed to bring new dimension to the quality and aesthetical understanding of the window standard, increase the comfort in your living areas with the excellent heat and sound insulation. With their oval lines, Garnet Selective Strong of Class A wall thickness and Garnet Strong both of whose all profiles have got 70 mm width, 5 chambered design and triple sealing system are the new choice of the architecture that seeks a different aesthetics. Garnet Selective Strong and Garnet Strong Series fulfil the expectations of the new trends

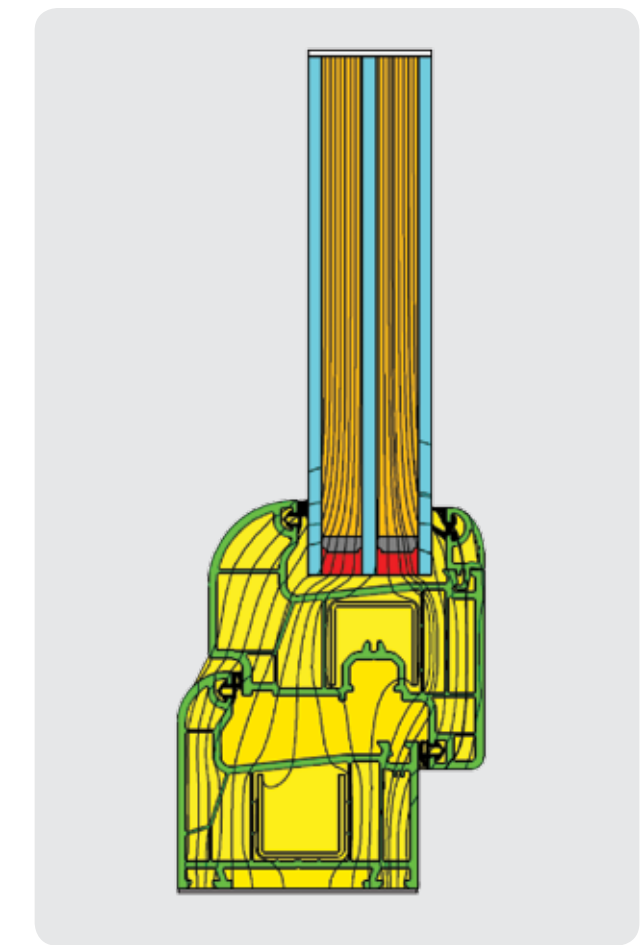

WINDOW HEAT FLOW DIAGRAM UF: 1,2 W/M² °K UW: 1,05 W/M² °K

Garnet and Garnet Selective series present options that will meet decorative expectations of your house and add value to it.

WIND LOAD RESISTANCE

→ Garnet system is designed according to 3.000 Pa (245 km/h) safety test on wind load and 600 Pa (110 km/h) water impermeability strength test, and it has successfully passed these tests.
 → The Garnet Selective Strong Series which has Class A wall thickness offers perfect solutions to provide resistance in high wind load structures,
 → While developing Garnet system, the maximum wind load values to which the buildings can be exposed were taken into consideration; the structure of the reinforcement steel and their locations inside the profiles were designed in the most effective way.
 → The system, whose detailed and box profiles provide solutions to meet the architectural needs, easily ensures the closure of the wide openings and necessary resistance values.

WATER AND AIR IMPERMEABILITY

→ Garnet Selective Strong and Garnet Strong Series were designed with triple sealing systems to provide water and air impermeability at minimum level.
 → Prevention of air passage from outdoors to indoors, which is necessary for energy saving, was improved with a middle seal in addition to inner and outer seals.
 → Thanks to its water drainage angle and sets to discharge the rainwater in a faster and easier way, Garnet system provides high resistance to water even at high wind loads.
 → The system did not let any water inside and proved its high quality under the tests carried out with 600 Pa (110 km/h) wind load and 4 liters of rainwater per minute.

HEAT INSULATION

→ While the profile designs of the Garnet Selective Strong and Garnet Strong Series were made, the value of the coefficient of thermal conductivity was intended to be at minimum levels, which is the most important part of energy saving.
 → Profile width, chamber numbers and chamber width of the system were created to keep the heat and sound insulation at the maximum levels.
 → With the 3rd middle seal system, the best possible values in a PVC window system have been reached.
 → All profiles of Garnet system have a structure of 5 chambers and since the chamber width is large, low level thermal conductivity coefficient values are provided.
 → Compatible with TS EN ISO 10077-2 standards, Ug: 0.7 W/m²K, Uw: 1,05 W/m²K, and Uf: 1.2 W/m²K values were accomplished with the windows system which has a size of 1,23m x 1,43m.

SOUND INSULATION

→ One of the most important criteria in window systems is the sound insulation. High sound levels about 70dB in the areas close to airports, railways or crowded highways are decreased to values under 30 dB with Garnet Selective Strong and Garnet Strong systems, at which a child can sleep easily.
 → Sound insulation up to 40 dB value can be provided with Garnet Selective Strong and Garnet Strong series. Therefore, it is possible to create a sound environment at a high quality life level even at the loudest places.



PROFILE WIDTH
70 mm

WALL THICKNESS
GARNET SELECTIVE STRONG **A CLASS**
GARNET STRONG **B CLASS**

NUMBER OF SEALS
3

NUMBER OF THE CHAMBERS
5 pcs

AIR PERMEABILITY CLASS
4

WATER IMPERMEABILITY CLASS
9A

WIND LOAD RESISTANCE CLASS
C3

SOUND INSULATION
40 db

PROFILE HEAT INSULATION
1,2 W/m² °K

WINDOW HEAT INSULATION
1,05 W/m² °K

GLASS THICKNESS
5, 20, 24, 32, 40 MM

The calculations were made by using a glass unit with a thermal conductivity coefficient of 0,7 W/m² °K for a window with dimensions of 1,23x1,43 m in accordance with the standard TS EN ISO 10077-2.

56

57

GARNET 70 SERIES MAIN & AUXILIARY PROFILES



FRAME PROFILE

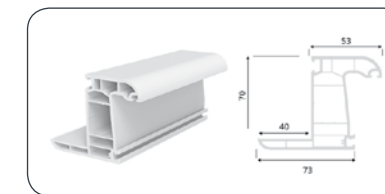

LINING FRAME PROFILE

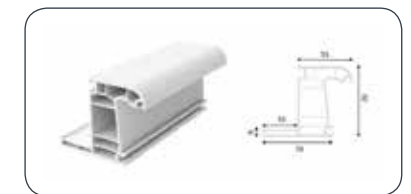

35 MM LINING FRAME PROFILE

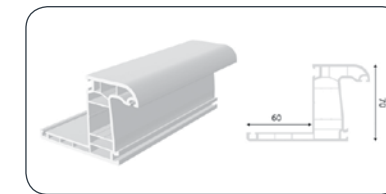

WIDE LINING FRAME PROFILE

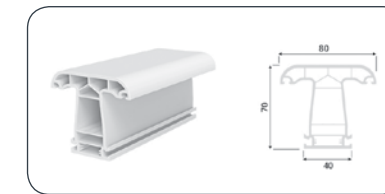

MULLION PROFILE

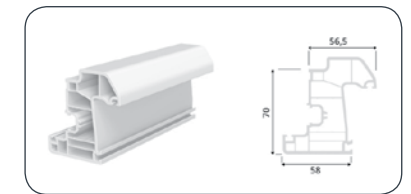

DRAINED SASH PROFILE

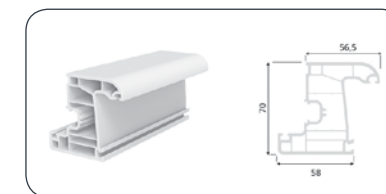

SASH PROFILE

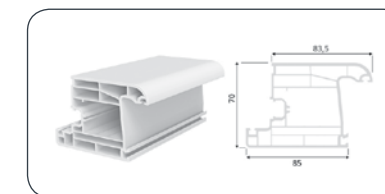

INSIDE OPENING DOOR PROFILE

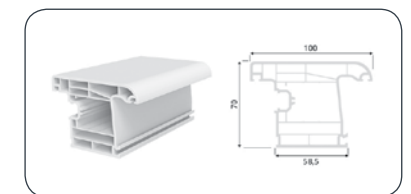

OUTSIDE OPENING DOOR PROFILE

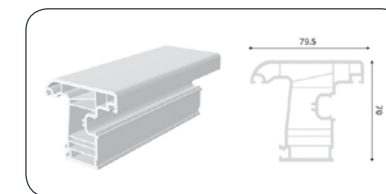

OUTSIDE OPENING SASH PROFILE

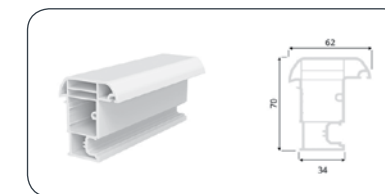

SASH ADAPTING PROFILE

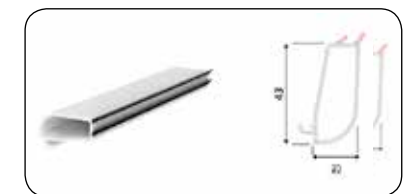

SINGLE GLAZING BEAD PROFILE (5 MM)



DOUBLE GLAZING BEAD PROFILE (20 MM)



DOUBLE GLAZING BEAD PROFILE (24 MM)



TRIPLE GLAZING BEAD PROFILE (32 MM)

**SELENIT 75
&
SELENIT
SELECTIVE**



SELENIT 75 WINDOW WITH A MONO-BLOCK ROLLER BLIND AND AN ADAPTER

- Together with the auxiliary profiles that are integrated into the main profiles, it aims to bring a solution to each architectural and technical detail.
- Triple glazing up to 44 mm thickness can be applied.
- The system is suitable for usage with 13-axis espagnolettes.
- The resistance values of the system enable its usage on high-rise structures.
- The lamination which comes in 21 different colors and textures provides you a choice for both indoor and outdoor use.

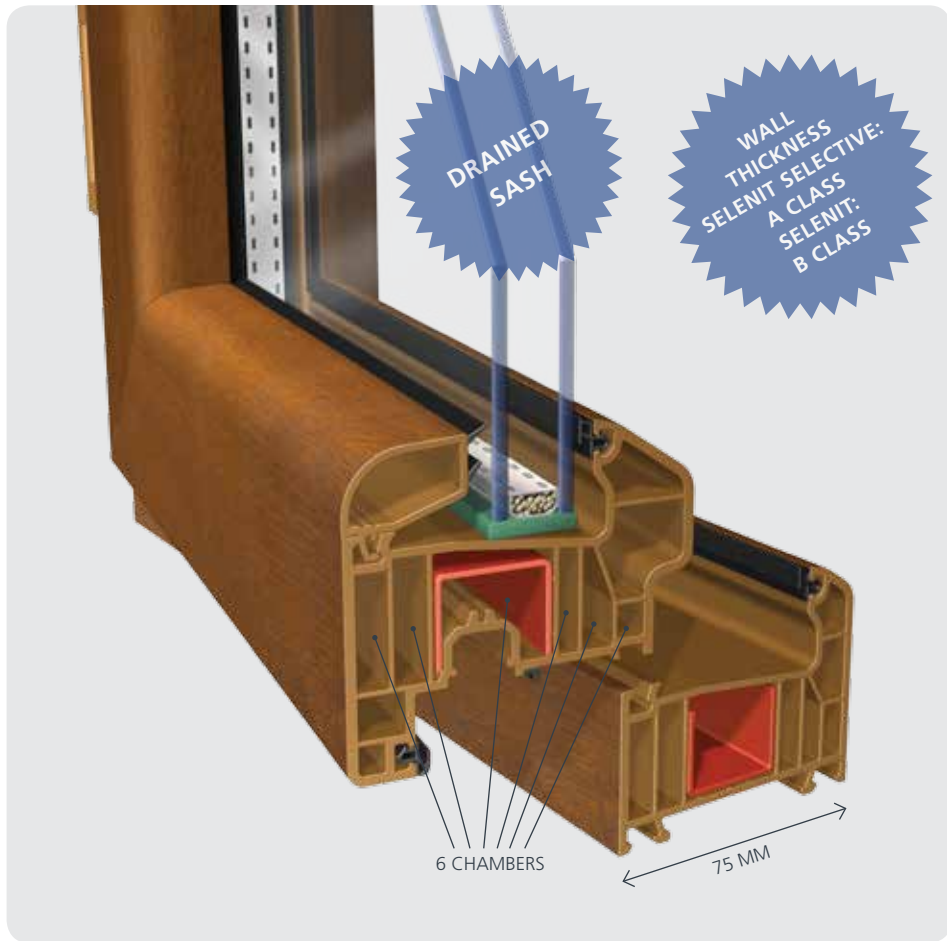

FRAME & SASH WIDTH 75 MM



TECHNOLOGY AND DESIGN ARE UNITED IN SELENIT AND SELENIT SELECTIVE

WIND LOAD RESISTANCE

- During the design stage of Selenit and Selenit Selective, the moments of inertia of the reinforcement steels to be used within the system and the relevant "wind load resistance" were minded at the highest level.
- The Selenit Selective Series which has Class A wall thickness, offers perfect solutions for providing resistance in structures with high wind load.
- The Selenit and Selenit Selective offer new solutions that can be utilized safely to provide coverage for high-rise structures and wide spaces.
- The box profiles in the system can easily meet the ideal resistance values required for covering wide spaces in respect to architectural design.

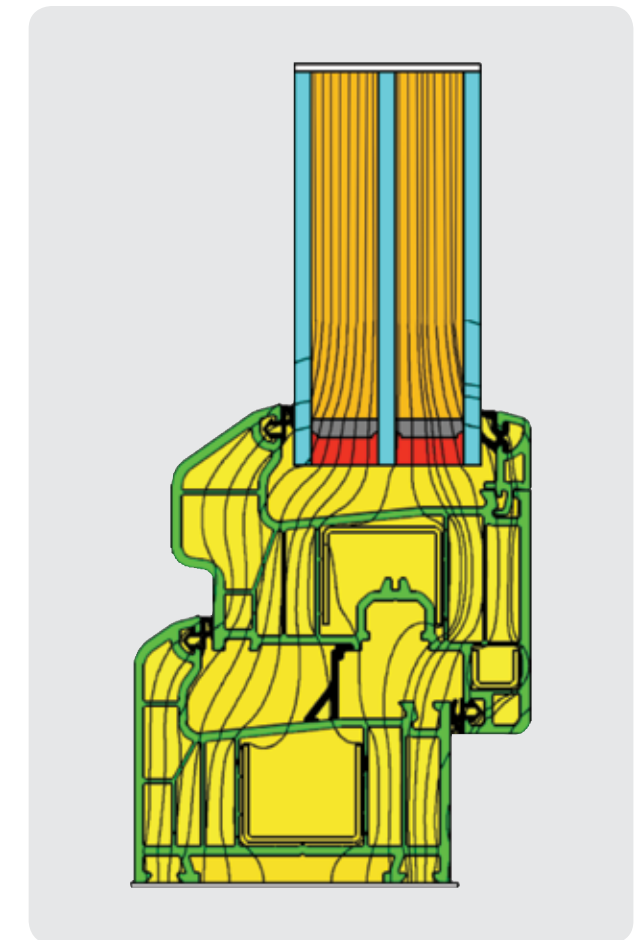

WINDOW HEAT FLOW DIAGRAM UF:1,02 W/M² °K UW: 0,94 W/M² °K



NEW ERA OF WINDOWS

SELENIT & SELENIT SELECTIVE

Selenit Selective Series which has Class "A" Wall Thickness together with Selenit Series, designed at the highest level of aesthetics, performance and durability standards, offer a new window for modern structures. The series were developed for those who were looking for a solution that captures the zeitgeist under the changing life culture and living space concepts. The Selenit and Selenit Selective Series offer a complete system with its 75-millimeter profile width, 6 chambered design, which enable them to achieve the highest levels of performance. The series offer alternative solutions

for architectural and decorative needs of your house with different colour options and aesthetical edges. The series develop different alternatives that are compatible with your furniture, wall color and the outer façade of the buildings.

QUALITY IN HARMONY WITH AESTHETICS AND PERFORMANCE

SYSTEM

- All system profiles of the Selenit Series have a width of 75 millimeters.
- Selenit Selective Series has Class A wall thickness; Selenit Series has Class B wall thickness.

→ The high endurance values of the Selenit and Selenit Selective passed the (3.000 Pa 245 km/h) safety test successfully and were categorized in class C3 regarding the wind load resistance.

FOR THOSE WHO SEEK A SOLUTION ABOVE STANDARD IN NEW GENERATION STRUCTURES
WATER AND AIR IMPERMEABILITY

→ The profiles were designed with a slope and appropriate for drainage channels with the aim of discharging the rainwater that may leak into the system.

→ The system did not let any water inside and proved its high quality during the tests carried out with 600 Pa (110 km/h) wind load and 4 liters of rainwater per minute.

MORE COMFORT WITH OUTSTANDING "HEAT AND SOUND INSULATION"

HEAT INSULATION

→ In accordance with the standard TS EN ISO 10077-2, the Selenit System achieved the values $U_f: 1,02 \text{ W/m}^2 \text{ °K}$ - $U_w: 0,94 \text{ W/m}^2 \text{ °K}$ according to the results of the test with $U_g: 0,6 \text{ W/m}^2 \text{ °K}$ glass of 1,23 m x 1,43 m dimensions.
→ The main profiles of the Selenit and Selenit Selective Series have 6 chambers and the chambers were designed as wide as possible. This enables them to minimize the coefficient of thermal conductivity.

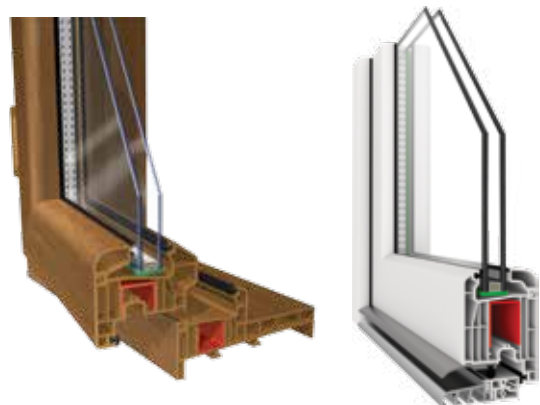

FRENCH FRAME PROFILE ALUMINIUM SILL SYSTEM

→ The profile designs of the Selenit and Selenit Selective Series were made as for the values related to the coefficient of thermal conductivity to be at minimum levels.

SOUND INSULATION

→ The high sound insulation of the Selenit and Selenit Selective Series provide the noiseless environment in the best way, which is necessary for life quality.

→ The glasses with acoustic properties which will be used with the system makes it possible to reach sound insulation levels as high as 43 dB.

→ The Selenit Series ensures normal noise levels even in environments such as airports, railroads, etc. where sound levels are very high.

SELENIT SILL SYSTEM

The Selenit Sill System is designed to eliminate the height created by the lower frame of the Selenit door system, and provide an aesthetic appearance. By means of the aluminum sill profile, inner plastic sill profile and the sill bead utilized in this system, the sill system's weakness in heat insulation is eliminated. Moreover, aesthetic integrity is also maintained while rapid discharge of water and rain that can penetrate from the outside is ensured by means of the aluminum dripstone profile mounted on the door.



BLOCK FRAME PROFILE



PROFILE WIDTH
75 mm

WALL THICKNESS
SELENIT SELECTIVE **A CLASS**
SELENIT **B CLASS**

NUMBER OF SEALS
2

NUMBER OF CHAMBERS
6 pcs

AIR PERMEABILITY CLASS
4

WATER IMPERMEABILITY CLASS
9A

WIND LOAD RESISTANCE CLASS
C3

SOUND INSULATION
43 db

PROFILE HEAT INSULATION
1,02 W/m² °K

WINDOW HEAT INSULATION
0,94 W/m² °K

GLASS THICKNESS
20, 24, 32, 42, 44 MM

The calculations were made by using a glass unit with a thermal conductivity coefficient of **0,6 W/m² °K** for a window with dimensions of **1,23x1,43 m** in accordance with the standard **TS EN ISO 10077-2**.

SELENIT SERIES MAIN & AUXILIARY PROFILES

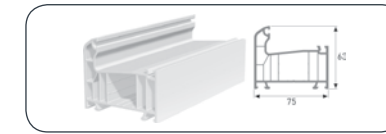

FRAME PROFILE



FRENCH FRAME PROFILE

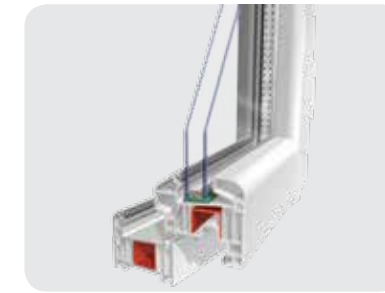

BLOCK FRAME PROFILE

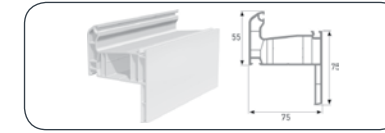

LINING FRAME PROFILE



FRAME PROFILE WITH CLOSING

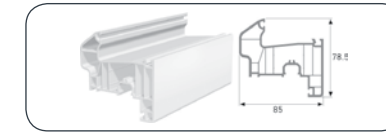

DRAINED SASH PROFILE

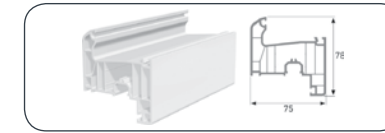

SASH PROFILE

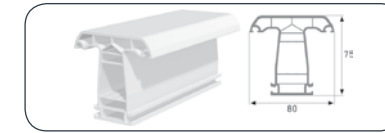

MULLION PROFILE



OUTSIDE OPENING SASH PROFILE



SASH ADAPTING PROFILE

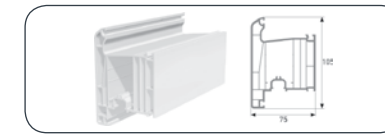

OUTSIDE OPENING DOOR PROFILE



FACADE MULLION PROFILE

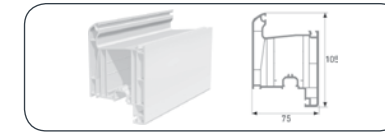

INSIDE OPENING DOOR PROFILE

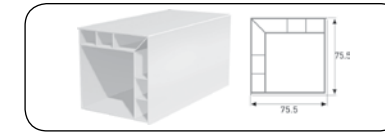

ANGLED POST BOX 90° PROFILE

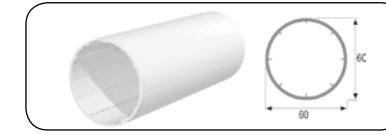

ANGLED POST ADAPTING PIPE PROFILE

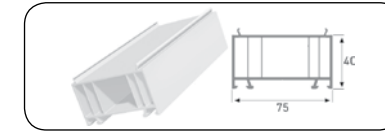

FRAME ELEVATION PROFILE (40 MM)



DRAINED INSIDE OPENING DOOR PROFILE

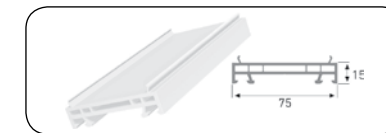

FRAME ELEVATION PROFILE (15 MM)

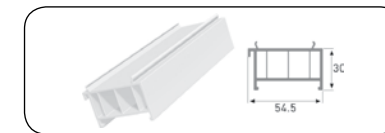

FRAME BASE MONTAGE PROFILE

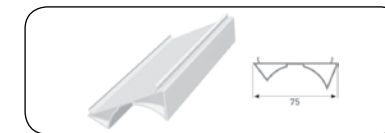

ANGLED POST ADAPTING PROFILE



135° ANGLED POST PROFILE



20 MM DECORATIVE GLAZING BEAD PROFILE



24 MM DECORATIVE GLAZING BEAD PROFILE

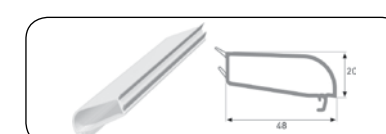

SINGLE GLAZING BEAD PROFILE (5 MM)

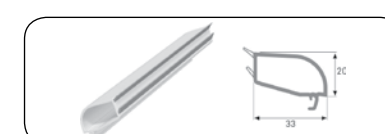

DOUBLE GLAZING BEAD PROFILE (20 MM)



CONCAVE 20 MM BEAD



CONCAVE 24 MM BEAD

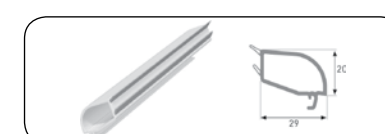

DOUBLE GLAZING BEAD PROFILE (24 MM)

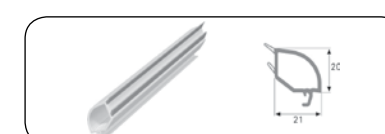

TRIPLE GLAZING BEAD PROFILE (32 MM)

SELENIT
STRONG
&
SELENIT
SELECTIVE
STRONG



SELENIT SELECTIVE STRONG WINDOW WITH AN ADAPTER

into the main profiles, it aims to bring a solution to each architectural and technical detail.

- Triple glazing up to 44 mm thickness can be applied.
- The system is suitable for usage with 13-axis espagnolettes.
- The resistance values of the system enable its usage on high-rise structures.
- The lamination which comes in 21 different colors and textures provides you a choice for both indoor and outdoor use.

TECHNOLOGY AND DESIGN ARE UNITED IN SELENIT SELECTIVE STRONG AND SELENIT STRONG
WIND LOAD RESISTANCE

- During the design stage of Selenit Selective Strong and Selenit Strong, the moments of inertia of the reinforcement steels to be used within the system and the relevant "wind load resistance" were minded at the highest level.
- The Selenit Selective Strong and Selenit Strong offer new solutions that can be utilized safely to provide coverage for high-rise structures and wide spaces.
- The box profiles in the system can easily meet the ideal resistance values required for coverage of wide spaces in respect to architectural design.
- The high endurance values of the Selenit Selective Strong and Selenit Strong Series passed the (3.000 Pa 245 km/h) safety test successfully and was categorized in class C3 in regard to wind load resistance.

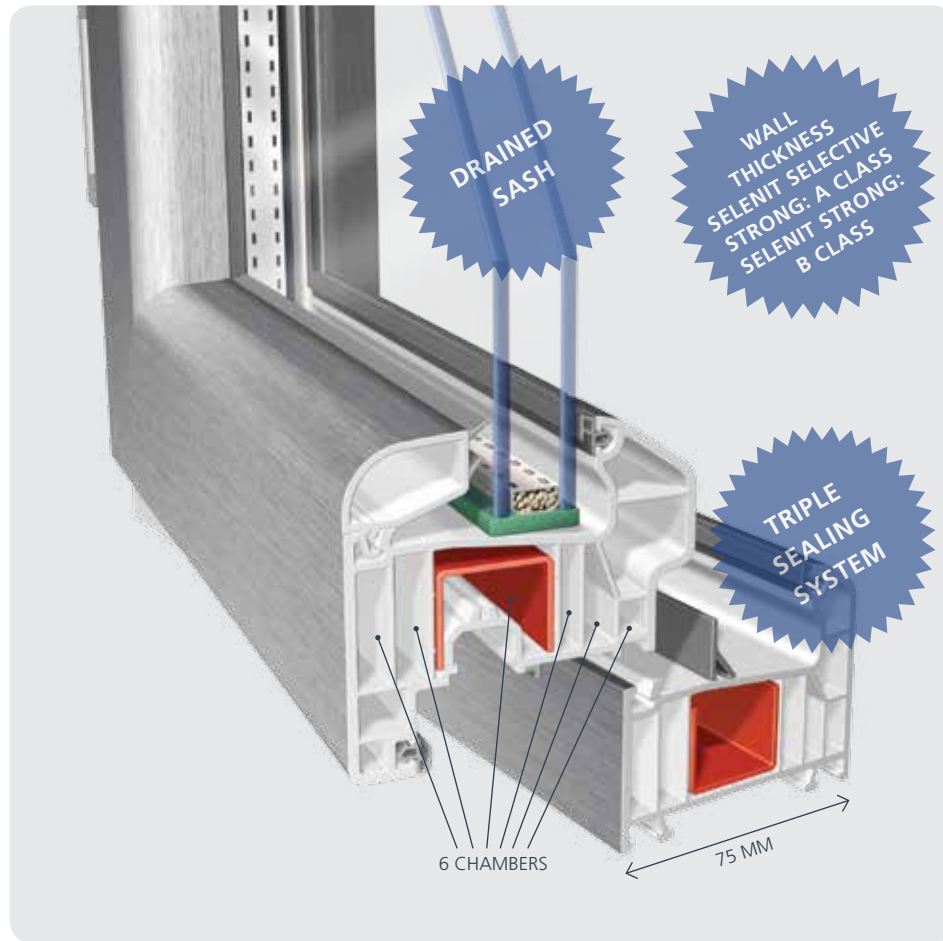

FRAME & SASH WIDTH 75 MM



selenit75
Strong

selenit75
Selective Strong

NEW ERA OF WINDOWS:
SELENIT SELECTIVE STRONG & SELENIT STRONG
Designed at the highest level of performance and durability standards, the Selenit Selective Strong, which has triple seal system and Class A wall thickness and the Selenit Strong, again with triple seal system, offer a new window for modern structures. The series were developed for those who were looking for a solution that captures the zeitgeist under the changing life culture and living space concepts. The Selenit Selective Strong offers a complete system with its Class A wall thickness, 75-millimeter profile width, 6 chambers design and 3rd seal option, which enable it to achieve the highest levels of performance. The series offer alternative solutions for

architectural and decorative needs of your house with different colour options and aesthetical edges. The series develop different alternatives that are compatible with your furniture, wall color and the outer façade of the buildings.

QUALITY IN HARMONY WITH AESTHETICS AND PERFORMANCE **SYSTEM**

- All system profiles of the Selenit Selective Strong and Selenit Strong Series have a width of 75 mm. The Selenit Selective Strong Series has Class A wall thickness and triple seal system while the Selenit Strong Series has Class B wall thickness and triple seal system.
- Together with the auxiliary profiles that are integrated

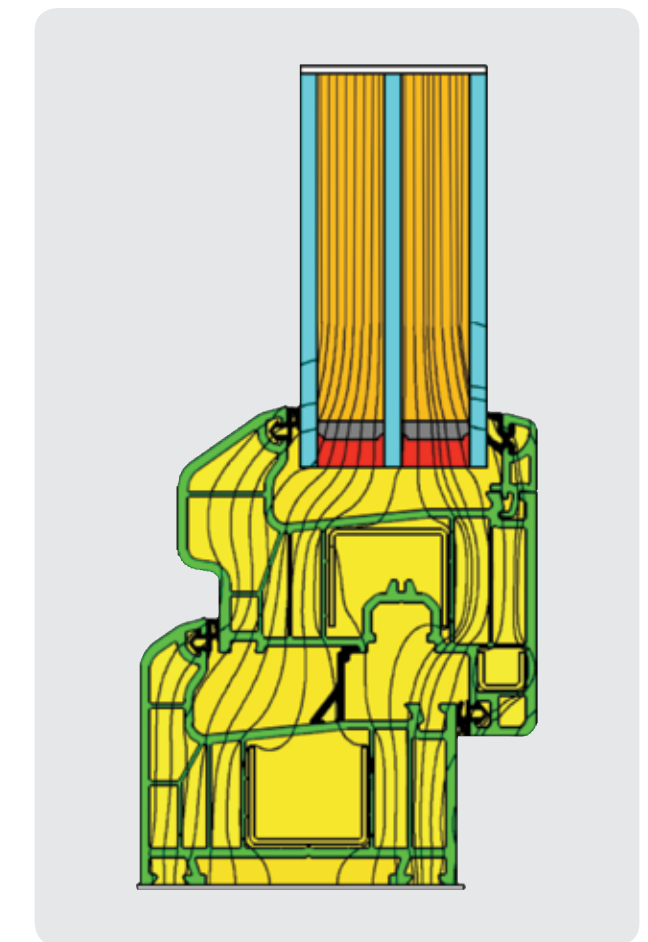

WINDOW HEAT FLOW DIAGRAM UF: 1,02 W/M² °K UW: 0,94 W/M² °K

FOR THOSE WHO SEEK A DIFFERENT SOLUTION FOR NEW GENERATION STRUCTURES

WATER AND AIR IMPERMEABILITY

→ In order to minimize air and water permeability, Selenit Selective Strong and Selenit Strong series were designed with a triple seal system.
 → Prevention of air passage from outdoors to indoors, which is necessary for energy saving, was improved with a middle seal in addition to inner and outer seals.
 → The profiles were designed with a slope and appropriate for drainage channels with the aim of discharging the rainwater that may leak into the system
 → The Selenit Selective Strong and Selenit Strong did not let any water inside and proved its high quality while under tests carried out with 600 Pa (110 km/h) wind load and 4 liters of rainwater per minute.

MORE COMFORT WITH OUTSTANDING "HEAT AND SOUND INSULATION"

HEAT INSULATION

→ In accordance with the standard TS EN ISO 10077-2, the Selenit System achieved the values $U_f: 1,02 \text{ W/m}^2 \text{ }^\circ\text{K}$ - $U_w: 0,94 \text{ W/m}^2 \text{ }^\circ\text{K}$ according to the results of the test with $U_g: 0,6 \text{ W/m}^2 \text{ }^\circ\text{K}$ glass of 1,23 m x 1,43 m dimensions.
 → The main profiles of the Selenit Selective Strong and Selenit Strong Series have 6 chambers and the chambers were designed as wide as possible. This enables them to minimize the coefficient of thermal conductivity.

→ Owing to the 3rd seal (optional) in the middle, the insulation performance is increased to the highest level possible in a PVC system.
 → The profile designs of the Selenit Selective Strong and Selenit Strong Series were made as for the values of the coefficient of thermal conductivity to be at minimum levels.

SOUND INSULATION

→ The high sound insulation properties of the Selenit Selective Strong and Selenit Strong Series provide the noiseless environment that is necessary for life quality in the best way.
 → The glasses with acoustic properties which will be used in the Selenit Selective Strong and Selenit Strong Series make it possible to reach sound insulation levels as high as 43 dB.
 → The Selenit Selective Strong and Selenit Strong Series ensure normal noise levels even in environments such as airports, railroads, etc. where sound levels are very high.

SELENIT SILL SYSTEM

The Selenit Sill System is designed to eliminate the height created by the lower frame of the Selenit door system, and provide an aesthetic appearance. By means of the aluminum sill profile, inner plastic sill profile and the sill bead utilized in this system, the sill system's weakness in heat insulation is eliminated. Moreover, aesthetic integrity is also maintained while rapid discharge of water and rain that can penetrate from the outside is ensured by means of the aluminum dripstone profile mounted on the door.

SELENIT SERIES MAIN & AUXILIARY PROFILES

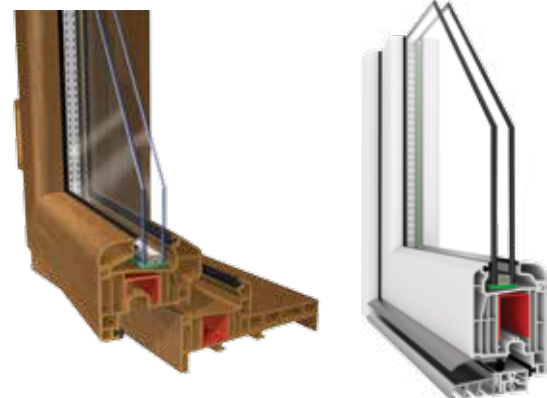
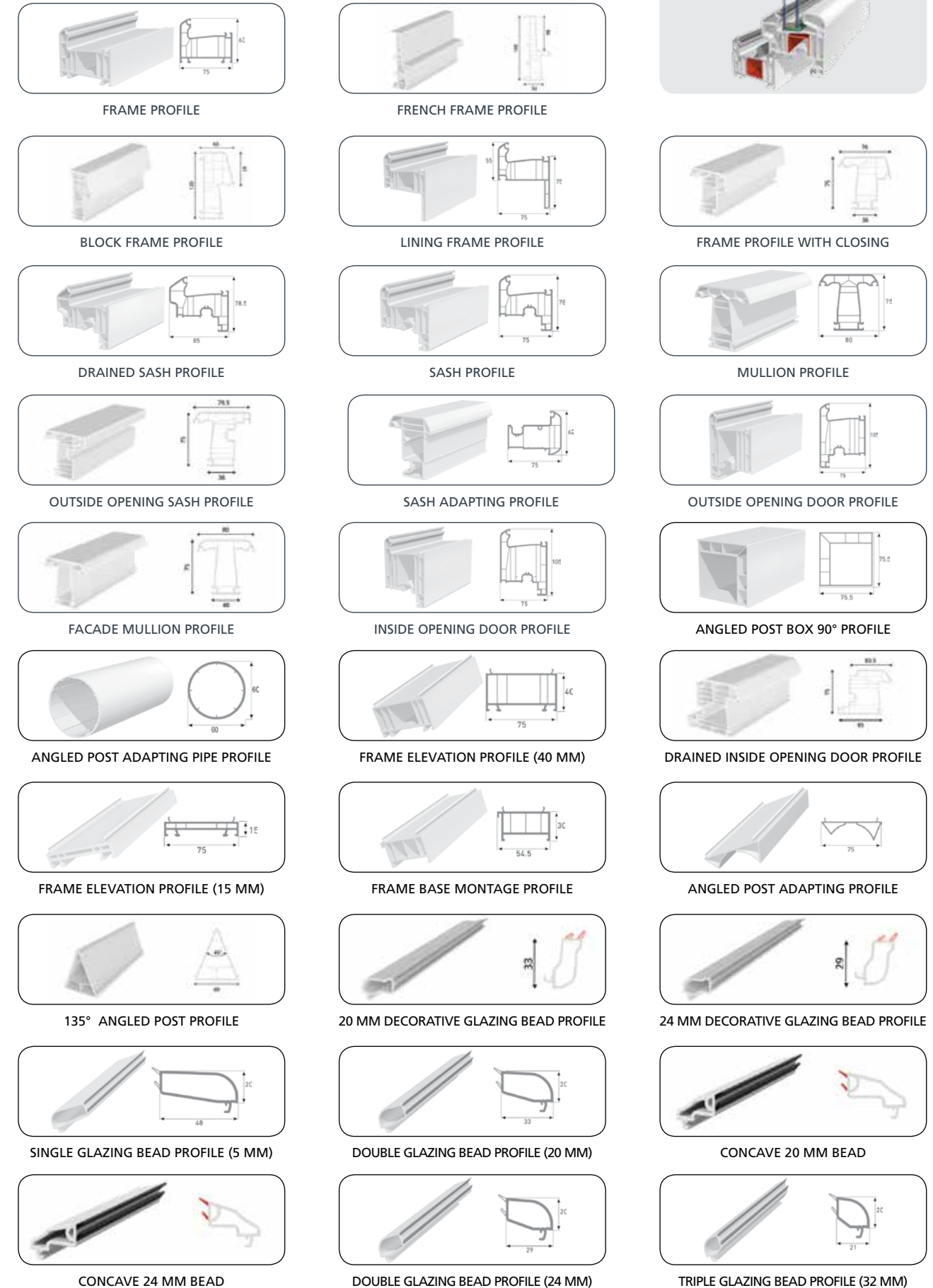

FRENCH FRAME PROFILE ALUMINIUM SILL SYSTEM



BLOCK FRAME PROFILE

WALL THICKNESS
SELENIT SELECTIVE
STRONG **A CLASS**
SELENIT STRONG **B CLASS**

NUMBER OF SEALS
3

PROFILE WIDTH
75 mm

NUMBER OF CHAMBERS
6 pcs

AIR PERMEABILITY CLASS
4

WATER IMPERMEABILITY CLASS
9A

WIND LOAD RESISTANCE CLASS
C3

SOUND INSULATION
43 db

PROFILE HEAT INSULATION
1,02 W/m² °K

WINDOW HEAT INSULATION
0,94 W/m² °K

GLASS THICKNESS
20, 24, 32, 42, 44 MM

The calculations were made by using a glass unit with a thermal conductivity coefficient of **0,6 W/m² °K** for a window with dimensions of **1,23x1,43 m** in accordance with the standard **TS EN ISO 10077-2**.



ELEGANCE 80
&
ELEGANCE
SELECTIVE 80



AESTHETICSS

Window production meeting various aesthetic and decorative expectations is possible with lamination color options. Different color foils can be used, inside and outside, depending on the building façades and indoor decoration. While wooden laminate options provide traditional wood aesthetics; it is also possible to make windows providing a consistent aluminium look by using different shades of grey, mainly aluminium brush effect and anthracite. Thanks to its sharp and wide edges, Elegance 80 system is a product that fits to the modern buildings and raises their values. It provides savings through high heat insulation.

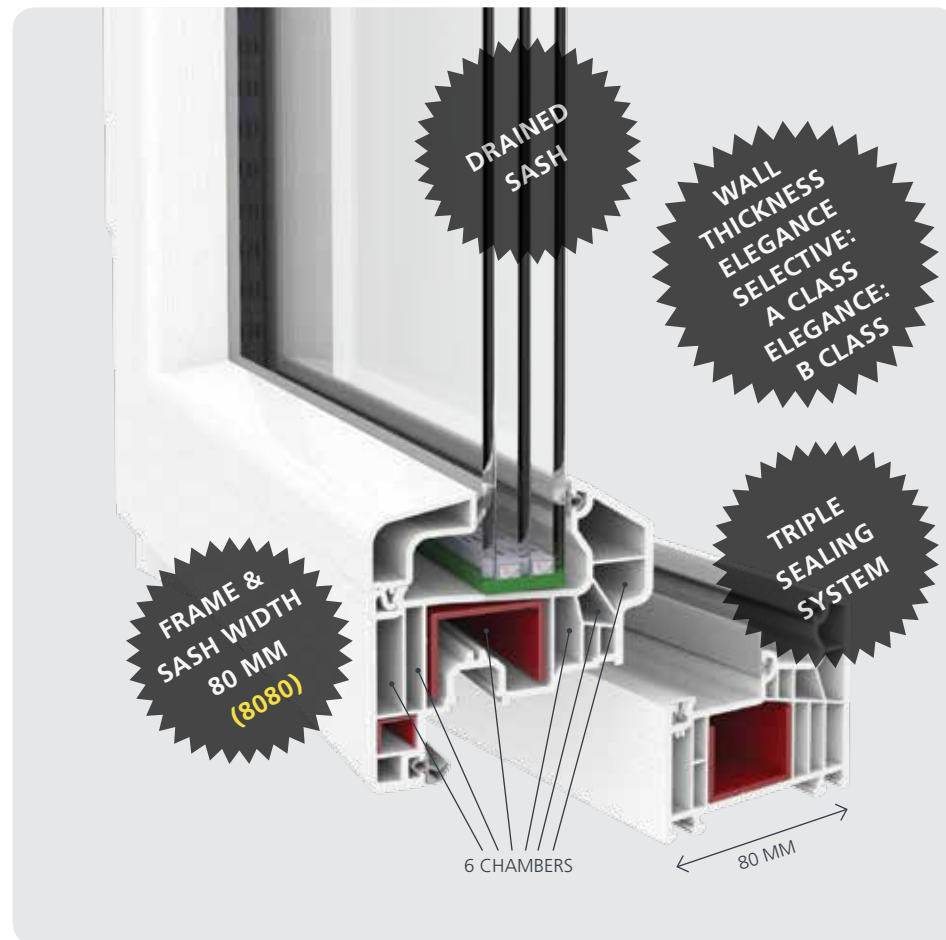

FRAME & SASH WIDTH 80 MM



SYSTEM

- All profiles are 80 mm wide.
- Elegance Selective has Class A wall thickness; Elegance has Class B wall thickness.
- It's designed as 6 chambered.
- Triple sealed.
- To provide full insulation of the middle seal, sashes are sloped.
- Thanks to the water draining system on the frame, 100% water impermeability is provided by discharging the water from inner and outer sides of the middle seal.

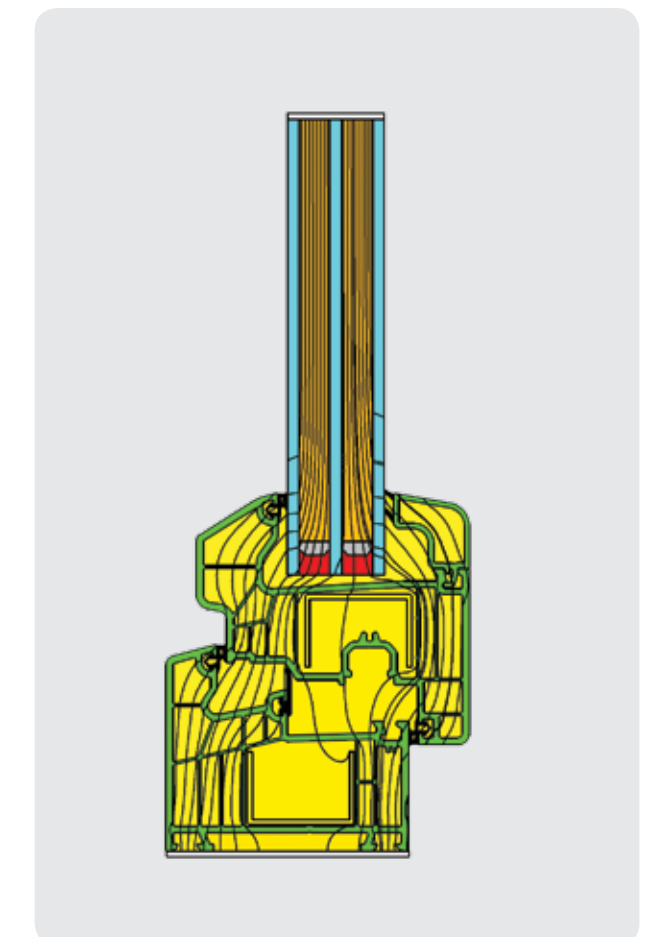

WINDOW HEAT FLOW DIAGRAM UF:1,02 W/M² °K UW: 0,91 W/M² °K

elegance80
elegance80
Selective

ELEGANCE 80 & ELEGANCE SELECTIVE

Elegance and Elegance Selective systems provide more performance than what is desired from a window; they carry the quality to the highest point by combining insulation, power, and aesthetic criteria; and become a new solution partner for the projects. The system providing perfect heat insulation with its 80 mm-wide profiles, its design with 6 chambers and its triple sealing system, is specially designed for the discharge of water from outer environment. Full insulation of the middle seal was provided by the slope in the sash design. The special design which provides superior durability

against the high wind load on multi-storey buildings, provides excellent performance without need for additional profiles suchlike grillage thanks to wide mullion profile. The Elegance Selective which has Class A wall thickness offers perfect solutions for all requirements of the projects where there are high-rise buildings and high wind load. The Elegance offers alternative solutions for decorative expectations of buildings and your house with different color options and aesthetic edges. The series develops different alternatives that are compatible with your furniture and wall color and the outer façade of buildings.

→ It is appropriate of 13 axis espagnolette system.
 → It is designed in such a manner to easily produce a solution for all architectural details with its detailed and auxiliary profiles.

WIND LOAD RESISTANCE

→ Elegance system is designed pursuant to 3.000 Pa (245 km/h) safety test on wind load and 600 Pa (110 km/h) water impermeability strength test and it has successfully passed these tests.
 → The Elegance Selective Series which has Class A wall thickness for providing resistance in high wind load structures, offers perfect solutions.
 → During the design stage of system, shape of reinforcement steels, their locations in the profile, and the maximum wind load that the existing structures may be exposed to, were all considered.

WATER AND AIR IMPERMEABILITY

→ High endurance against rain was provided even on the high wind load thanks to its drainage angle and sets developed to drain the water in a faster and simpler way.
 → The system did not let any water inside and proved its high quality under the tests carried out with 600 Pa (110 km/h) wind load and 4 liters of rainwater per minute.
 → Water leak was totally blocked with the triple sealing system.

→ Thanks to the mullion profile that has a wide surface, high performance is provided even in the high-rise buildings and high wind loads, without need for any additional profiles such as box profile.

HEAT INSULATION

→ Elegance 80 system was designed to reach the highest values of heat insulation by taking into consideration the middle gasket, reinforcement steel, number and location of chambers, and all points that form a heat bridge.
 → By blocking the flow of heat from indoors to outdoors in winter, and vice versa in summer, through a special frame and sash seals and triple middle sealing features it saves energy both in summer and winter.
 → In accordance with the standard TS EN ISO 10077-2, with a glass system of dimensions 1.23 m x 1.43 m, the following values have been achieved: Ug: 0.6 W/m2K, Uw: 0.91 W/m2K, and Uf: 1.02 W/m2K.

SOUND INSULATION

→ Because of the usage of acoustic glasses in Elegance 80 system, indoor environment quality is enhanced by providing high sound insulation values.
 → Elegance Series provides isolated and comfortable environments even in flats placed near highways and airports by maintaining sound insulation up to 40 dB levels.

ELEGANCE SERIES MAIN & AUXILIARY PROFILES

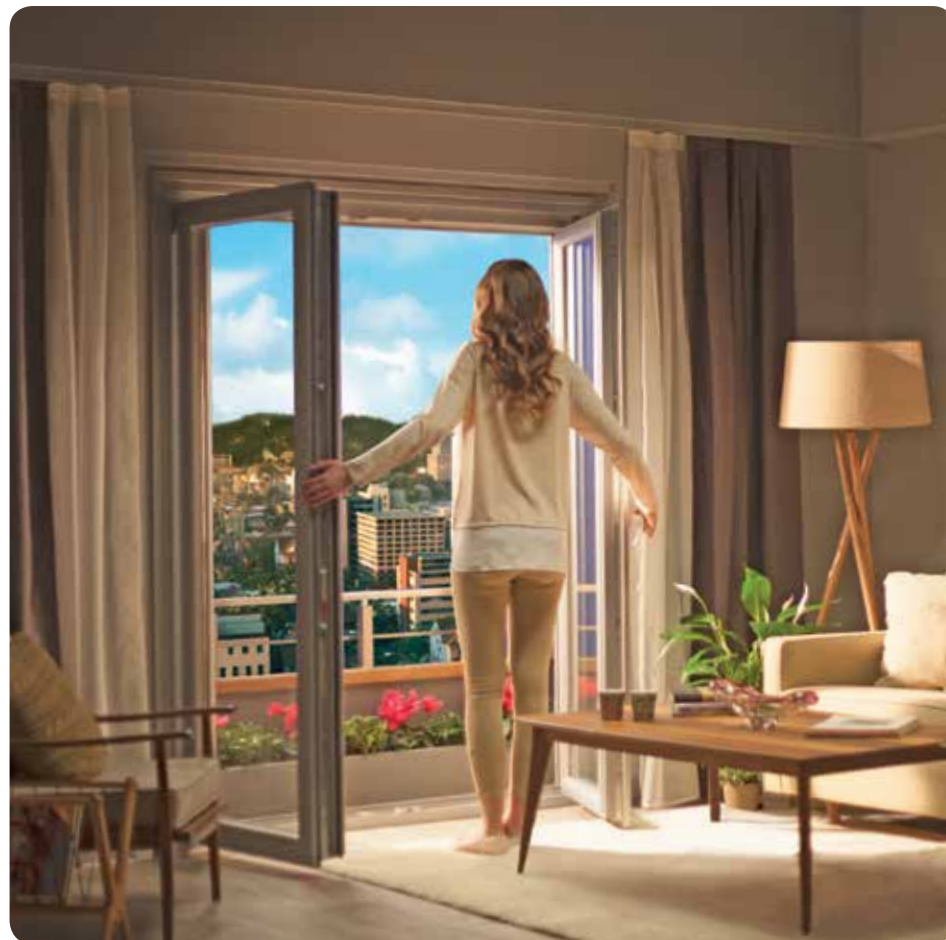

PROFILE WIDTH
80 mm

WALL THICKNESS
 ELEGANCE SELECTIVE **A CLASS**
 ELEGANCE **B CLASS**

NUMBER OF SEALS
3 (MIDDLE SEALING)

NUMBER OF CHAMBERS
6

SEAL
TPE GREY / BLACK

PROFILE HEAT INSULATION
1,02 W/m² °K

WINDOW HEAT INSULATION
0,91 W/m² °K

SOUND INSULATION
40 db

AIR PERMEABILITY
CLASS 4

WATER IMPERMEABILITY
CLASS 9A

WIND LOAD RESISTANCE
CLASS C3

GLASS THICKNESS (MM):
24,32,36

The calculations were made by using a glass unit with a thermal conductivity coefficient of **0,6 W/m² °K** for a window with dimensions of **1,23x1,43 m** in accordance with the standard **TS EN ISO 10077-2**.

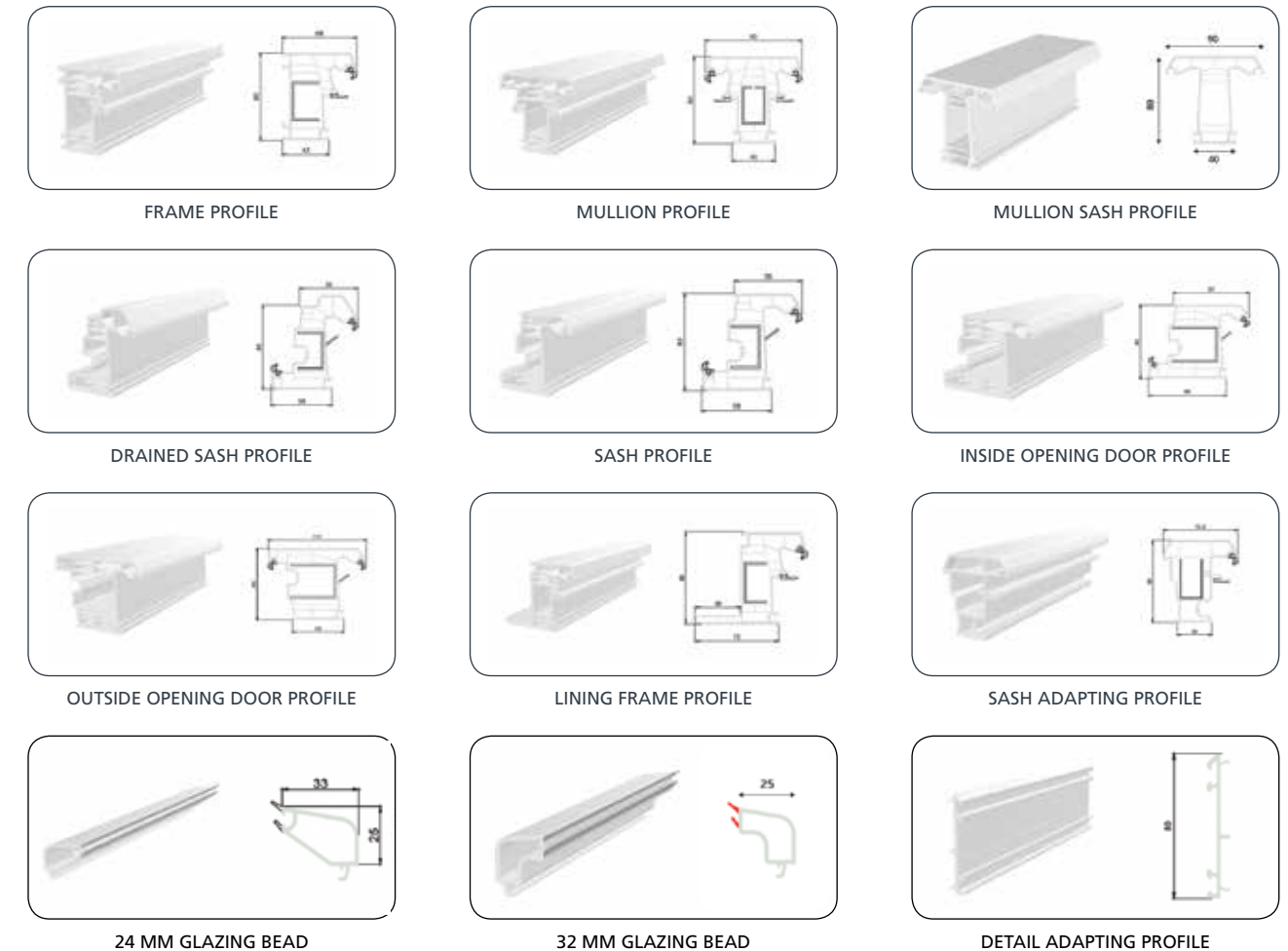

ZENIA SLIDE



for the purpose. The fact that energy is the most limited and expensive resource gives "energy conservation" in window systems, which is actually insulation, even more prominence. Firat is blazing a new trail on this subject by presenting the "Zenja Slide" which eliminates the insulation problems with sliding systems used in residences and offices. When the windows are closed, the "Insulated Sliding Systems" ensure insulation at all points via EPDM seals. Thus, external factors such as wind, noise and rain are prevented from being transferred inside.

AESTHETICS

The frame and sash profiles of "Zenja Slide Systems" were designed to be at the same level, for ensuring a complete,

for doors and windows in order to facilitate passage over thresholds.

→ The frame and sash profiles of the system were connected via welding method and the system was designed to be manufactured with the minimum amount of profiles at maximum speed.

→ Since each sash can carry up to 200 kgs, the system can be applied for a wide range from the smallest windows to the largest doors.

→ Sash connection points are the weakest points in sliding systems. The special interlock profile used in these points enables the insulation to be provided through two EPDM seals and sliding seal brush.

→ The special locking feature of interlock profiles completely eliminates the risk of window sashes pulling away from each other due to wind.

→ The gap in the connection point of the two upper horizontal sashes, which constitutes another weakness in sliding and parallel sliding systems, has been eliminated with the specially designed insulation profile and sliding stopper.

→ The profile specially designed for purposes of providing aesthetic conformity for the upper gap between the frame and the sash and sealing the gap also ensured the system integrity to remain unharmed.

WIND LOAD RESISTANCE

→ The "Zenja Slide" has very high wind load resistance by means of its locking system and interlock profile structure and is able to provide the same air impermeability performance values as high-insulation window systems.

→ While developing "Zenja Slide" the maximum wind load values to which the buildings can be exposed were taken into the consideration; the structure of the reinforcement steel as well as their positions inside the profiles were designed in the most effective way.

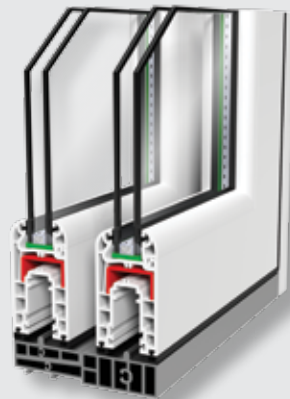

zenia
SLIDE
zenia
HEBESCHIEBE

AN ERA OF SUPERIOR INSULATION IN SLIDING SYSTEMS BEGINS

Today's, the importance of usage of energy resources and efficient usage and saving of energy is increased. 82% of the energy utilized by building complexes is used for heating purposes. This rate corresponds to approximately 26% of the total energy consumed in our country. The heat loss in buildings arises from various sources: 40% through exterior walls, 30% through windows, 17% through exterior and balcony doors, 7% through roofs and 6% through the undersides of flooring. Due to this circumstance, residences come to the forefront as the most important areas for energy saving and PVC window systems stand out as the best insulation systems

elegant look. With a range that extends from the smallest window to the largest doors that open to offices, gardens and terraces, the systems have a wide area of usage. With 21 different color and texture option, they meet the architectural and decorative expectations.

SYSTEM FEATURES

→ The system has 125-mm wide frame and 50-mm wide sash profile.

→ It can be used with two different glazing bead profile types of 20 mm and 24 mm.

→ When the windows are closed, the insulation at all points is ensured via EPDM seals.

→ Two different aluminum rail profiles were developed

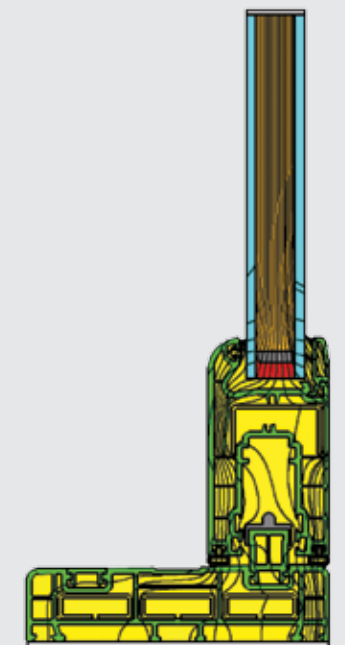

WINDOW HEAT FLOW DIAGRAM UF:1,7 W/M² °K UW: 1,6 W/M² °K

HEAT INSULATION

→ Profile width of "Zenia Slide", its chamber numbers, chamber widths, profile heights and EPDM seal systems were created to meet all the requirements regarding thermal conductivity coefficient.

→ Compatible with TS EN ISO 10077-2 standards, Ug : 1,1 W/m²K, Uw : 1,6 W/m²K and Uf : 1,7 W/m²K values were achieved with the Windows system which has the dimensions of 1,23 m x 1,43 m.

SOUND INSULATION

→ The "Zenia Slide" provides sound insulation with values up to 40 dB. Thus, the system makes it possible to attain an indoor sound level that accommodates a quality life, even in the noisiest environments.

→ The sound insulation level to be acquired via acoustic glasses that can be used with the system isolates the noise from the outside from indoors in the most efficient way.

ZENIA HEBESCHIBE

Zenia Hebeschiebe syetm is offered to the use of our customers with the addition of aluminum frame and aluminum double rail adapter used at the lower panel to the profiles of the Zenia Slide system. Hebeschiebe espagnolette and car systems can be used with the Zenia Hebeschiebe system. Thus, each wing reaches a bearing capacity of 300 kg. The Zenia Hebeschiebe systems, which can be used comfortably in the details of the building such as garden, pool and balcony outlets with large and high openings, bring you the ease of use and comfort of the slider system. The insulation advantage of the Zenia Hebeschiebe system adds value and comfort to your living spaces. The gasket interlock system used in the Zenia Hebeschiebe system provides ease of use and insulation values at the highest level thanks to the EPDM gaskets used at all points, the upper insulation profile and the special profiles preventing the sash shakiness.

INSULATED SLIDING SERIES TECHNICAL DETAILS



It provides excellent insulation by the help of EPDM seals used at **FRAME AND SASH** connection points.



With the help of **UPPER INSULATION PROFILE**, air passage between two upper sashes is prevented.

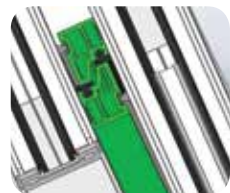

Insulation is provided in **INTERLOCK SYSTEM** by the help of seals, sliding seal brush and locking system.



Isolation weakness occurring in vertical direction is prevented by attaching the **UPPER INSULATION BUFFER** over the interlock profiles.

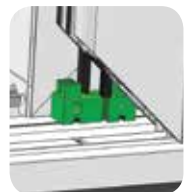

With the help of **INTERLOCK BUFFER** air passage in the base section of interlock profiles is prevented.



Aesthetical look is achieved with the help of **LOWER SLIDING PLUG** without need for manually cutting the sliding sash closing profile in rail shape and the risk of closing profile to grind over the rail is removed.

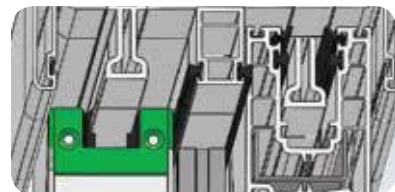

Aesthetical look is achieved with the help of **UPPER SLIDING PLUG** without the need for manually cutting of the sliding sash closing profile in upper rail shape and the risk of closing profile to grind over the rail is removed.

- **Perfect insulation with EPDM gasket at all points**
- **High rain and sound insulation**
- **200 kg load bearing capacity for each sash.**
- **Ease of use and installation**
- **Easy sliding with 3 cm sill height**
- **Aesthetic look with 125 mm frame – 50 mm sash width**
- **Thanks to a special locking system, sash can be locked at a desired position**
- **21 different color options**
- **The advantage of being available as ready-made joinery**
- **Sashes can be in any desired number**
- **Any sash/sashes can be movable**
- **Cost advantage compared to all insulated sliding systems and hebeschiebe espagnolette**
- **The Zenia system can be transformed into a Hebeschiebe system with the use of an aluminum lower frame. Thus, the load bearing capacity of each sash is 300 kg.**

PROFILE WIDTH
125 mm

PROFILE HEAT INSULATION
1,7 W/m² °K

WINDOW HEAT INSULATION
1,6 W/m² °K

SOUND INSULATION
40 db

AIR PERMEABILITY CLASS
4

WATER IMPERMEABILITY CLASS
9A

WIND LOAD RESISTANCE CLASS
C3

GLASS THICKNESS
20, 24 MM

The calculations were made by using a glass unit with a thermal conductivity coefficient of **1,1 W/m² °K** for a window with dimensions of **1,23x1,43 m** in accordance with the standard **TS EN ISO 10077-2**.

72

73

ZENIA INSULATED SLIDING SYSTEMS SERIES MAIN & AUXILIARY PROFILES

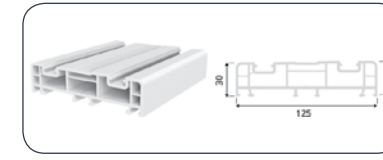

SLIDING FRAME PROFILE

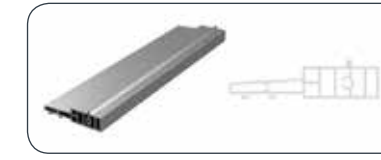

ALUMINUM LOWER



ALUMINUM DOUBLE RAIL FRAME ADAPTER

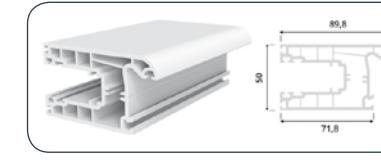

SLIDING SASH PROFILE

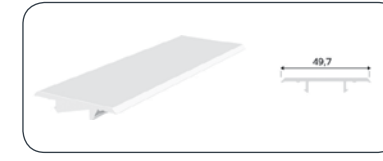

SLIDING SASH CLOSING PROFILE

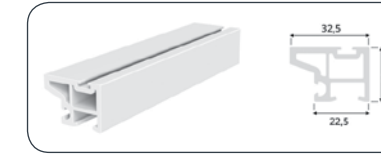

SASH CLAMP PROFILE

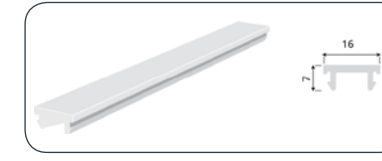

RAIL CHANNEL CLOSING PROFILE

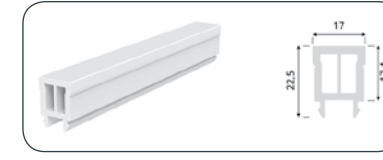

RAIL PASSING THE LOWER SIDE



RAIL PASSING THE UPPER SIDE

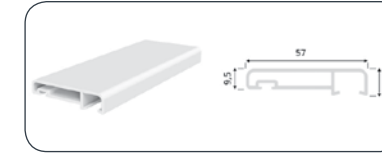

UPPER CLOSING PROFILE

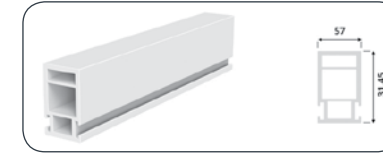

ADAPTER PROFILE WITH INSULATION



SLIDING DOUBLE GLAZING BEAD PROFILE (20 MM)



SLIDING DOUBLE GLAZING BEAD PROFILE (24 MM)



**ANDES
&
ANDES SLIDE**



SYSTEM FEATURES

- Andes Window System has a frame, a mullion and two different glazing bead profiles. Mullion Profile can also be used as outside opening sash profile.
- The system has two different glazing bead profiles that can be used in 5 and 20 mm-glass thickness. In cases where 24 cm glass is demanded, the main profile can be applied without using the seal.
- Profiles of Andes Window System have a profile width 38 mm.
- Locking is achieved through handle as transom system is used in Andes Window System. Outside opening is performed with the help of the latch on the sash handle. Sash is locked by the locking element on the frame tightening the handle latch.
- Andes Sliding System has a frame profile width of 60 mm which can operate in harmony with Andes Window System.
- Andes Sliding System has Sliding Frame Profile, Sliding Lining Frame Profile, Sliding Fix Frame Profile, Sliding Three Track Frame Profile and Sliding Frame Profile with Fly Swatter which can provide different solutions in different applications.
- In Andes Sliding System, fixed windows can be made by using the Fix Frame Profile. Developed especially for this aim, Sliding Fix Horizontal Mullion Profile is used as a mullion within the fix frame and thus, fixed glass can be applied in lower or upper parts.
- In order to make fixed joineries above or below the sliding frame, a "Frame Connection Profile" has been developed that connects the frames of Andes Sliding and Andes 38 mm.
- Special lining profiles designed for Andes frame and Andes Sliding frame profiles are available in the system.
- Post box profiles and connection profiles have been included in the system in order to offer solutions for different architectural applications.

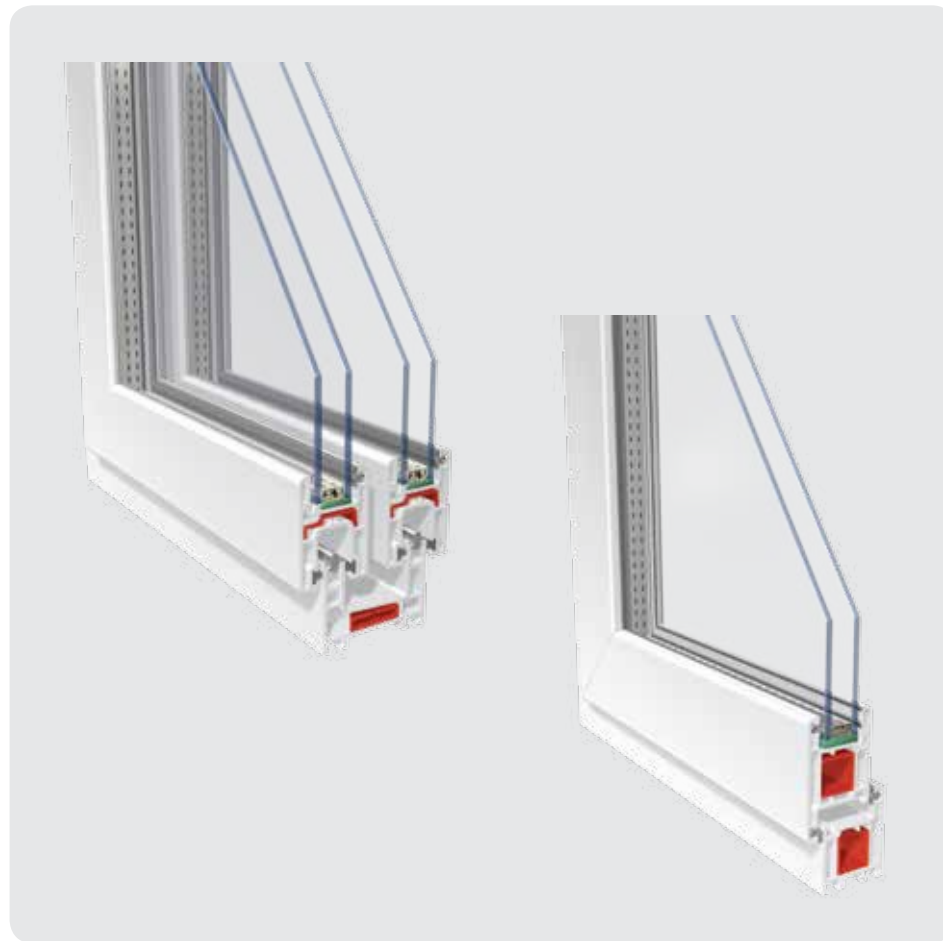

**PERFORMANCE FEATURES
OF THE WINDOWS SYSTEM**

Reinforcement steels, one of the most significant points for achievement of the required resistance values, have been designed in a way that it can provide the necessary inertia values. Thus, the system can provide necessary wind load, water and air impermeability in the area in which it will be used.

INNOVATIVE SOLUTIONS FOR VARIOUS REGIONS

ANDES AND ANDES SLIDING SYSTEM

PVC window systems can vary depending on the characteristics of the region they are used in. India and countries of Latin America, Africa and Middle East usually prefer "smaller profiles" or "outside opening" systems. Winhouse generates new solutions through "Andes" and "Andes Slide" systems specially designed for these regions.

AESTHETICS

Mullion Profile of Andes Window System is also used as outside opening sash profile. Since the width of Andes is 38 mm and its depth indoors is 36 mm, a small amount of profile is seen while we have a larger view of the outside benefitting from the sunlight more at the same time. 21 different color options are available for lamination in the system. Wood or aluminum effect can be achieved through lamination and thus, PVC windows matching the interior and the exterior of buildings can be manufactured.



PROFILE WIDTH
38 mm

NUMBER OF
THE CHAMBERS
3 pcs

GLASS THICKNESS
5, 20, 24 mm

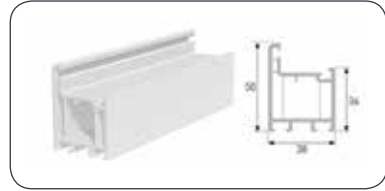

FRAME PROFILE

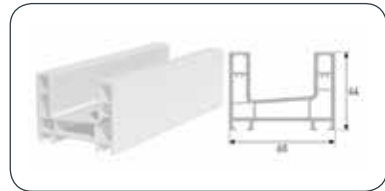

SLIDING FRAME PROFILE



FIX FRAME CLOSING PROFILE

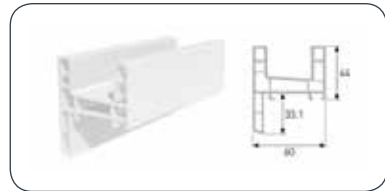

SLIDING FRAME PROFILE WITH LINING

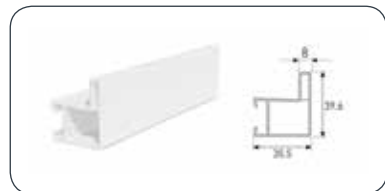

SLIDING FLY SWATTER FRAME PROFILE

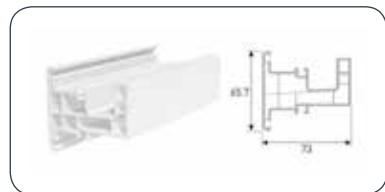

SLIDING FIX HORIZONTAL MULLION PROFILE

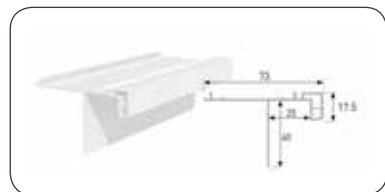

T LINING FOR SLIDING PR.

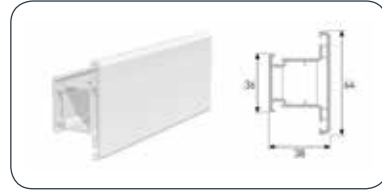

MULLION & OUTSIDE OPENING SASH PR.

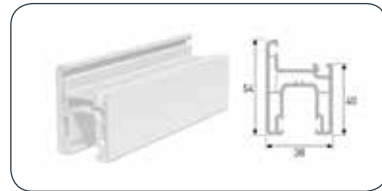

SLIDING SMALL SASH PROFILE

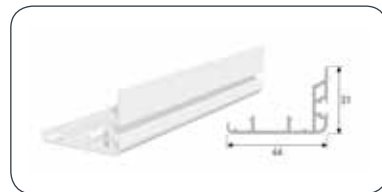

SLIDING SMALL SASH CLOSING PROFILE

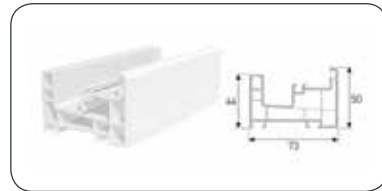

SLIDING FIX FRAME PROFILE

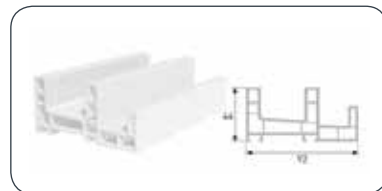

SLIDING FRAME PROFILE WITH FLY SCREEN

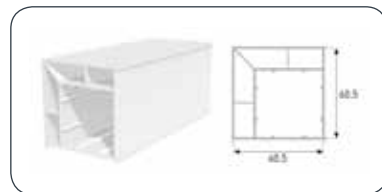

SLIDING POST BOX PROFILE

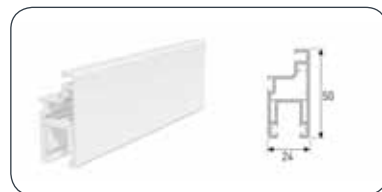

SLIDING FLY SWATTER SASH PROFILE

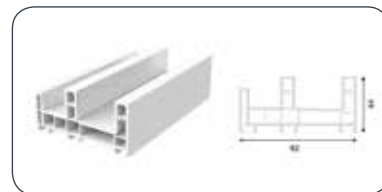

ANDES SLIDING FRAME PROFILE
WITH INSIDE FLY SCREEN

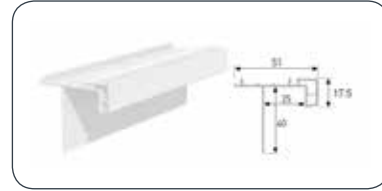

T LINING FOR FRAME PR.

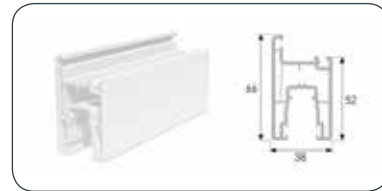

SLIDING BIG SASH PROFILE

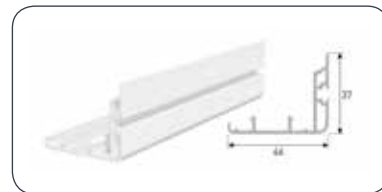

SLIDING BIG SASH CLOSING PROFILE

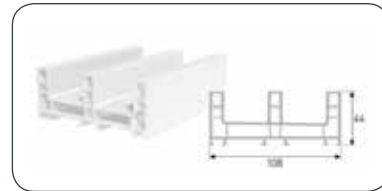

THREE TRACK SLIDING FRAME PROFILE

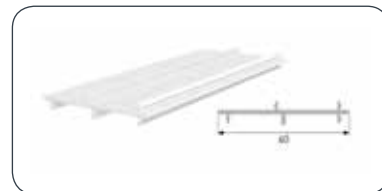

CONNECTION PROFILE FOR SLIDING FRAME

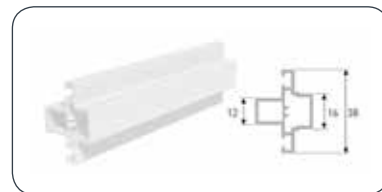

SLIDING SASH ADAPTING PROFILE



SLIDING FLY SWATTER MULLION PROFILE

76

77

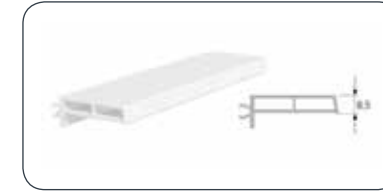

ZERO BASED LINING PROFILE

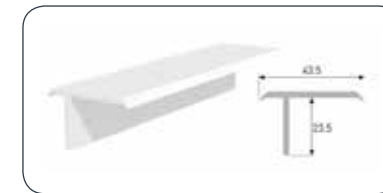

WIDE ASSIMETRICAL T PROFILE



NARROW ASSIMETRICAL T PROFILE



SLIDING ANGLED POST PIPE PROFILE



75X170 LINING PROFILE



COUPLING PROFILE

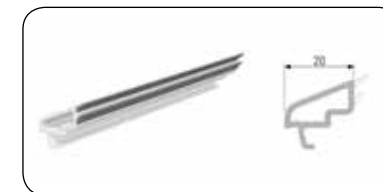

5 MM GLAZING BEAD PROFILE

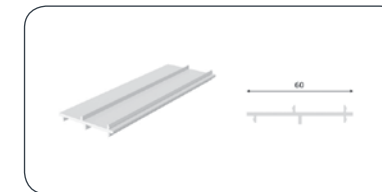

FRAME CONNECTION PROFILE

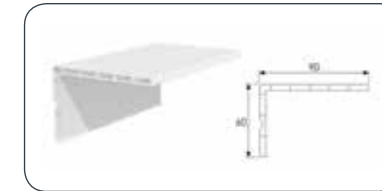

60X90 LINING PROFILE

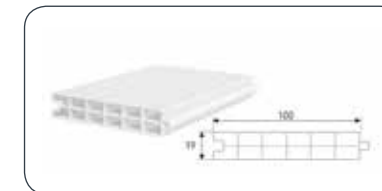

LAMBRI PROFILE (19X100 MM)



LINING LEADING PROFILE



20 MM GLAZING BEAD PROFILE

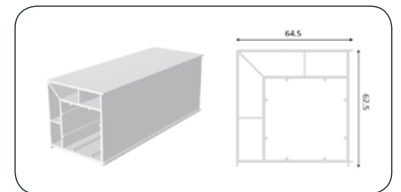

ANGLED POST BOX 90° PROFILE

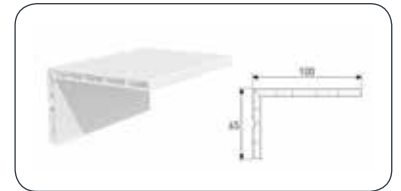

65X100 LINING PROFILE

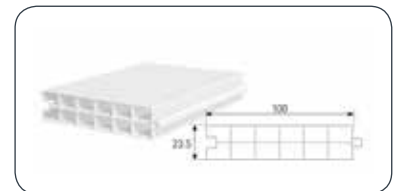

LAMBRI PROFILE (24X100 MM)



ADAPTING PROFILE WITH LINING

SLIDING SYSTEMS (70 MM & 75 MM)



AESTHETIC AND EASY TO USE

PVC window and door systems consist of two main joinery types. One of these is the sliding systems due to their ease of use and advantage of space they provide. The biggest advantage of the sliding systems is that they don't cause space loss as their sash is opened by sliding and settled on the other sash. Besides, ease of use and aesthetic appearance are the biggest pros of the sliding systems. Insulation in the sliding systems is achieved through brush systems named as weather stripping and thus, insulation is lower than normal window systems. However Winhouse has reduced insulation weakness to minimum levels through its special interlock systems used in the series of 70 mm and 75 mm.

AESTHETICS

The system provides a pleasant appearance and ease of use for the final consumer thanks to its suitable frames for different locations. Laminated coating with 21 different colors as well as white profile can be applied in the system. Thanks to patterns of 21 different laminated coating, wood and aluminum appearances can be provided on the PVC profile. Thus, PVC windows can be manufactured in harmony with the interior and exterior of the residence or building.

SYSTEM FEATURES

- Winhouse sliding systems have two different types and measures of 70 and 75 mm. In this way, dealers using Selenit series of 75 mm as well as the dealers using Garner series of 70 mm can integrate their sliding systems into the windows.
- Sash profiles of the sliding systems of 70 mm and 75 mm are the same. Although their frame measures are different, common sashes can be applied by using different sash closing profiles.
- Sliding fix frame profile with lining profile which can be used to carry out sash systems whose one side is fixed and the other side is moving has been included in the sliding system of 75 mm.
- Our frames with fly swatter are available in our sliding systems. Moreover, sliding frame with fly swatter having lining profile inside and outside are also available for their use in different regions.
- Fly swatter functioning by sliding in the Classic Sliding systems can cause tension in the fly screen net when used in high measures. This situation leads to stretch in the profiles. Sliding mullion profile used in sliding sash profile has been manufactured in order to prevent this stretch.
- For when fixed glass in the upper or lower parts of the sliding system, demanded fix profile of 70 and 75 mm has been developed to carry out an application without disrupting aesthetic appearance. Thanks to this profile, fixed glass can be manufactured through a simple application without disrupting the appearance.
- Three different sash types of the sliding system are available. Sliding door sash profile for the joineries in high measures and new sliding sash profile together with the sliding sash profile for small measures rank among the products of the sliding systems.
- 3 different bead profile types are available in the sliding systems of 70 and 75 mm to carry out application of single glazing of 5 mm and 20 and 24 mm of double glazing.

PERFORMANCE FEATURES OF THE WINDOWS SYSTEM

Because of having the insulation through weather-stripping and thus insulation weakness in the classic sliding systems, the sliding sash profiles in the sliding systems of 70 and 75 mm have been designed suitable for use of seal and thus insulation weakness has been minimized. Furthermore, wind load resistance has been maximized through the sliding door sash profile developed for high sized joineries.

SLIDING SERIES (70 MM) MAIN & AUXILIARY PROFILES

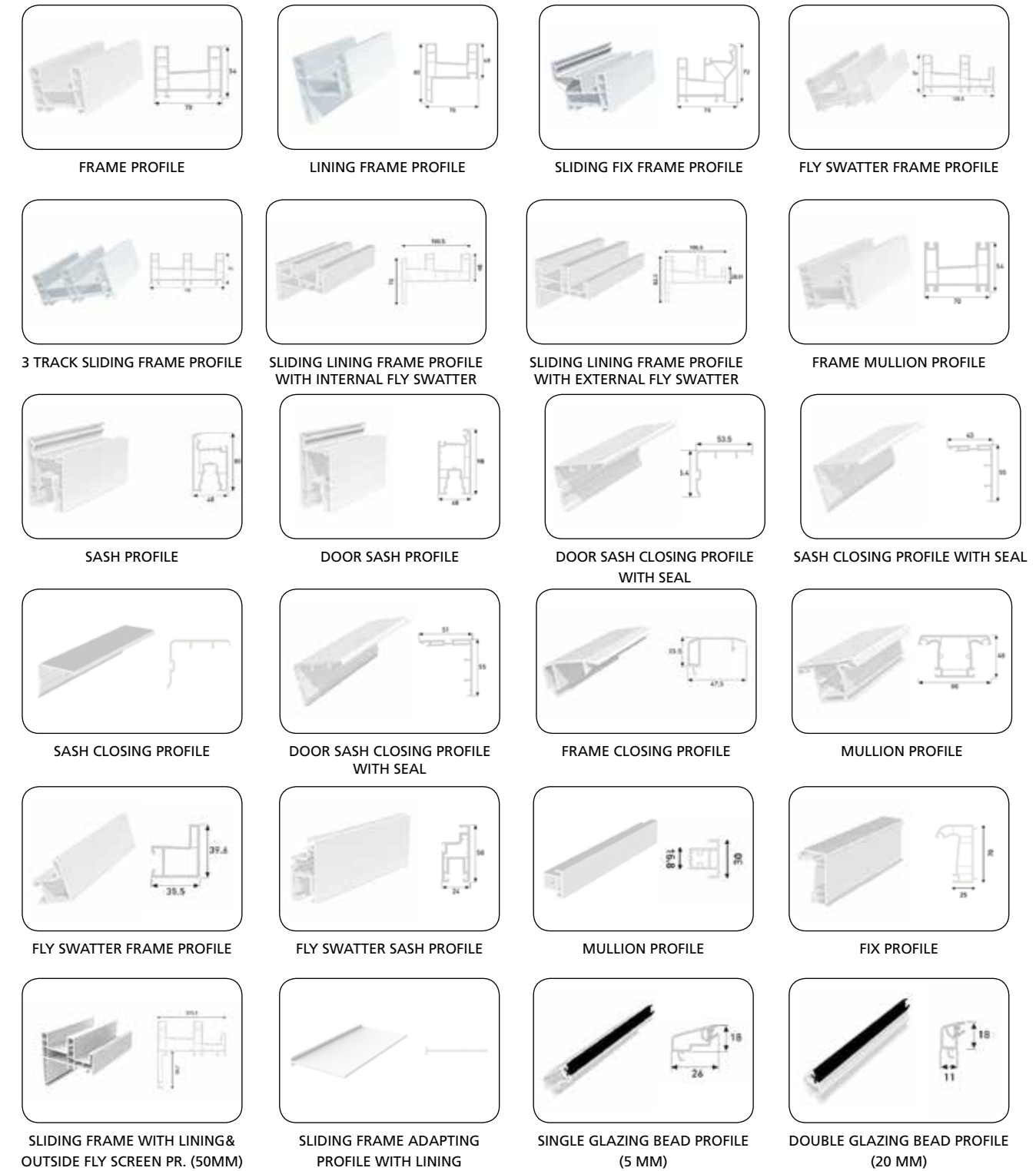

SLIDING SERIES (75 MM)
MAIN & AUXILIARY PROFILES

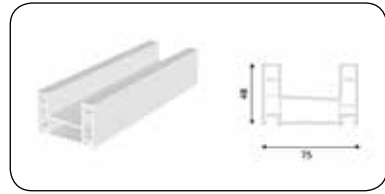
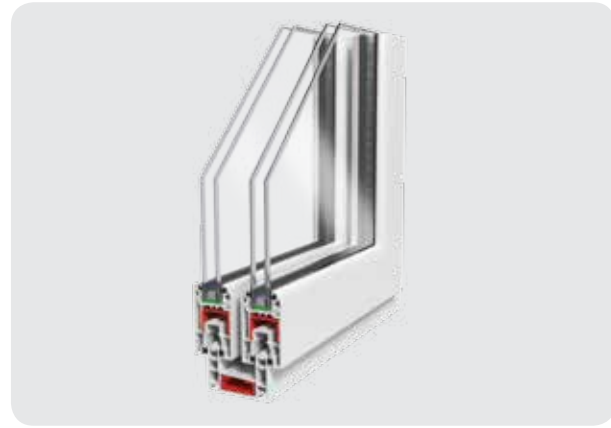

FRAME PROFILE

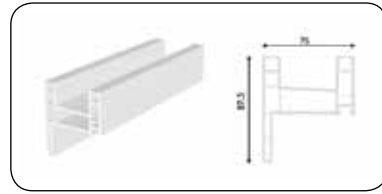

LINING FRAME PROFILE

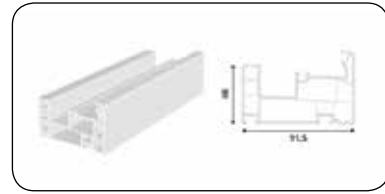

SLIDING FIX FRAME PROFILE

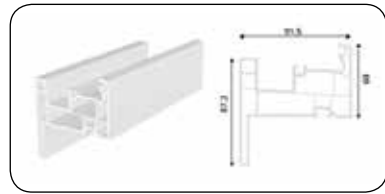

LINING FIX FRAME PROFILE

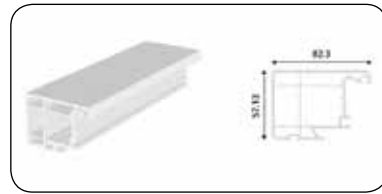

VERTICAL MULLION PROFILE



SASH PROFILE



DOOR SASH PROFILE

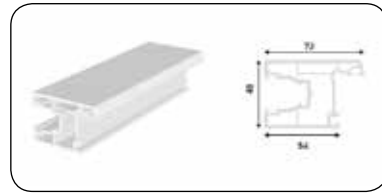

NEW SASH PROFILE

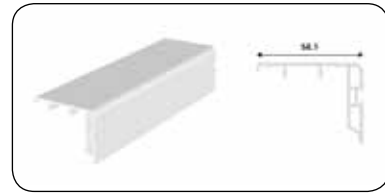

SASH CLOSING PROFILE

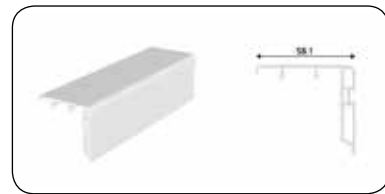

DOOR CLOSING SASH PROFILE

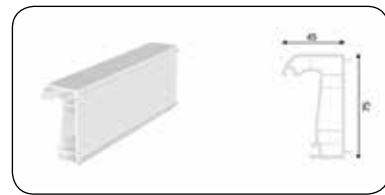

FIX PROFILE



80

81

SHUTTER SYSTEMS



Winhouse shutter systems compatible with all kinds of projects, provides controlled protection inside out in your building while offering ideal solutions for your modern architectural and decoration expectations with the rich accessory choices. It brings comfort and convenience to your living spaces with their design in harmony with the exterior surface of your buildings, choice of lamination coating having natural wood patterns, their aesthetic look and functionality.

- They are compatible with all Winhouse window and door system series.
- They can be easily used with all different door and window systems with their width up to 140 cm and height up to 240cm.
- It blocks entry of sunlight inside due to its immovable mount system in size of 80 mm x 35 mm at angle of 67°.
- It may also be used as ventilation grille due to its fixing option.
- While it is used for single wing applications, it may also be used for double wing applications by means of wing adapter profile.
- As PVC window profile formulation is used for its production, its resistance against challenging natural conditions and sunlight has excellent performance.
- Winhouse Shutter Systems are integrated and function excellently as all their parts are produced by us.
- They have manual and pneumatic hinge options.
- They have different color options.
- Their resistance against hard conditions was proved during the tests performed at FIRAT Laboratories.



**DETAILED
PROFILES**

Detailed profiles, as it can be understood from their names, are types of lambri and lining profiles and used in detailed solutions of window and door systems and commonly utilized in the product series. Detailed profiles have the same importance with regards to compatibility to the area, practical usage and their functions as the main profiles being the skeleton of the system. Since the detailed profiles are usually integrated with the main profiles rather than being used separately, they should not destroy the integrity and they need to be functional.

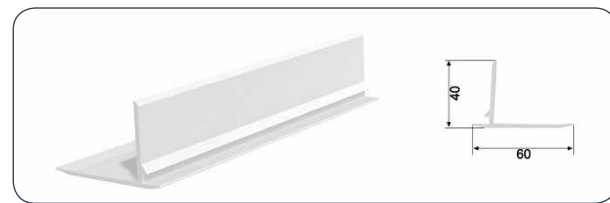

CLOSING PROFILE



BEAD CHANNEL CLOSING PROFILE



60 X 100 MM BOX PROFILE

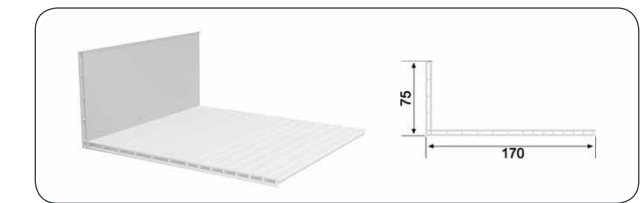

75 X 170 MM LINING PROFILE

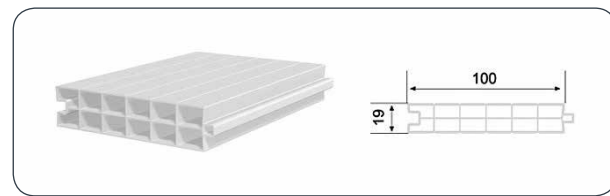

100X19 MM LAMBRI PROFILE



LINING LEADING PROFILE

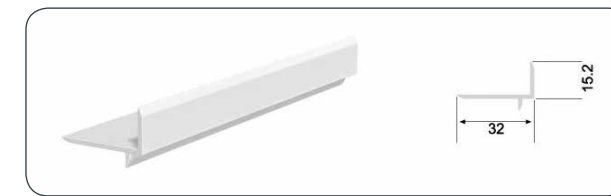

T-PROFILE

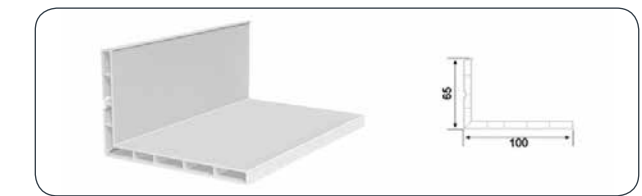

65X100 WINDOW LINING PROFILE

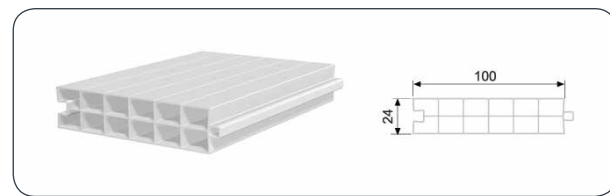

100X24 MM LAMBRI PROFILE

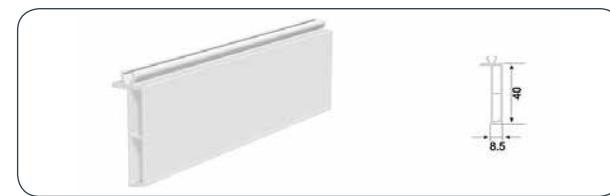

ZERO BASED LINING PROFILE

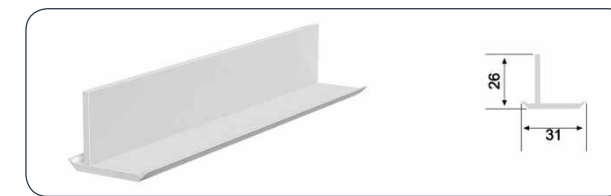

NARROW ASSIMETRICAL PROFILE



67,5X100 MM DOOR LINING PROFILE

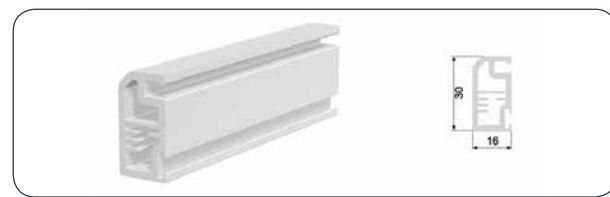

FLY SWEATTER PROFILE

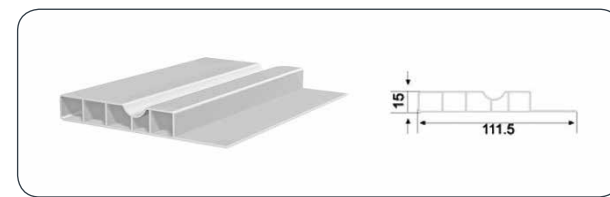

INDOOR SILL PROFILE

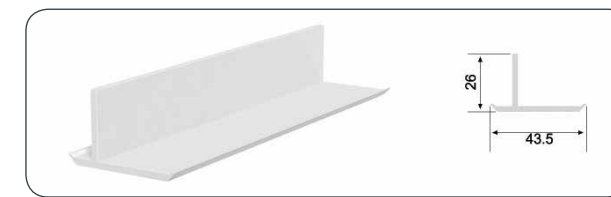

WIDE ASSIMETRICAL PROFILE

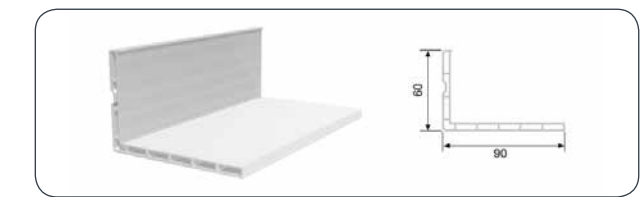

60X90 MM WINDOW LINING PROFILE

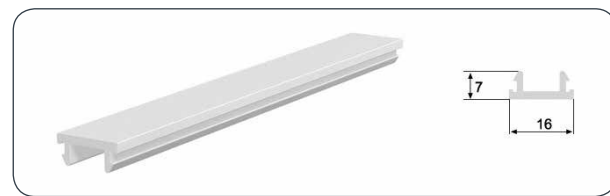

ESPAÑOLETTE CHANNEL CLOSING PROFILE



OUTDOOR SILL PROFILE



50 X 50 MM LINING PROFILE



15X20 MM CORNER PIECE PROFILE



PANE SEPARATING PROFILE

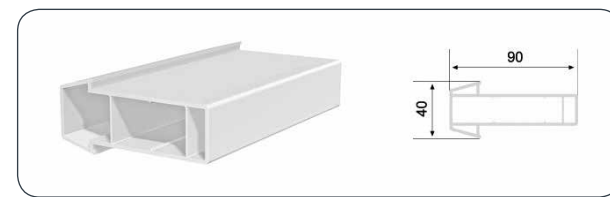

40 X 90 MM BOX PROFILE

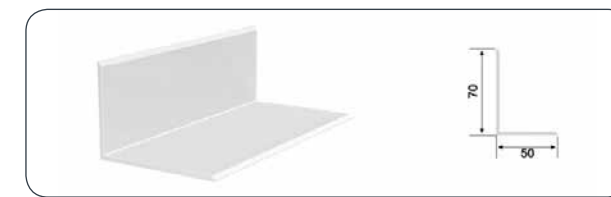

50 X 70 MM LINING PROFILE

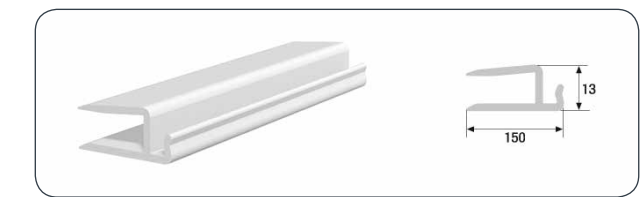

LINING ADAPTING PROFILE

ROLLER BLINDS

Providing excellent harmony with all projects, Winhouse Roller Blinds Systems offer ideal solutions for your architectural and decoration expectations with their Roller Blinds frame not projecting out the building exterior wall as well as their options of laminated cover of natural wood pattern, aesthetic look and functionalities. The most important specification which separates PVC mono block roller blinds systems from other PVC roller blinds systems is their ability to be assembled over the window rather than on the wall. Due to this reason PVC mono block roller blinds cannot be applied on the existing pvc windows. While the pvc windows are assembled, roller blinds are attached over the window and then assembled together with the window. Due to this reason they are named mono blocks.

84

85



Common Features of Winhouse Mono Block Roller Blinds Systems

- They can be produced with wooden patterns.
- They can be produced as manual roller blinds, roller blinds with electric motor and roller blinds with remote control.
- They have two different sizes of mount profile: 52 mm and 39 mm. Mount profiles could be either PVC or aluminum.
- Styrofoam is used within the frame in order to increase the insulation.
- With the use of PVC Roller Blinds Systems, window security is increased. Especially the roller blinds with motors are not possible to be opened from the outside.
- Roller blinds increase the insulation of current pvc window system by 30%.

There are 3 different types of mono block roller blinds in Winhouse product range.

- 19 cm Mono Block Roller Blinds
- 21 cm Mono Block Roller Blinds
- 23 cm Mono Block Roller Blinds

While heights of maximum 220cm could be covered with 19 cm roller blinds frames, with 21cm frames, 240cm; with 23 cm frames up to 260 cm open spaces could be covered. Swatter could be applied within the frame of 23 cm roller blinds.



19 CM MONO BLOCK ROLLER BLINDS



21 CM MONO BLOCK ROLLER BLINDS





PVC Roller Blinds Models and Features

- They are compliant with all Winhouse window and door system lines. They are easily used for all door and window systems with sizes that could reach 200cm width as a single part, 250 cm height with 23cm frame and 220cm with 19cm frame.
- With frame size of 23.5cm (235mm) and 19 cm, they may be applied to many window and door systems in different heights.
- With its two different sizes of mount profile, 35 mm and 52mm, its winding length is great, and it has different decorative looks.
- With its meeting rail profile it is possible to create roller blinds systems with two or more divisions.
- Removable blind frame cover allows maintenance and cleaning even after mounting.
- In-frame swatter is available in 23cm roller blinds. Cassette system is available for 19cm roller blinds system. It could be easily removed and re-assembled easily when necessary.
- Provides excellent heat insulation in the places it is used due to its in-frame insulation feature.
- Since PVC window profile formulation is used for its production, its resistance against challenging natural conditions and sunlight has excellent performance.
- Winhouse Roller Blinds Systems are integrated and works perfectly since all their parts are produced by us.

23 CM MONO BLOCK ROLLER BLINDS



- They can be used with a remote controller or manually.
- There are laminated wooden patterns and different color options.
- Their resistance against hard conditions was proved during the tests performed at FIRAT Laboratories.

Mono block Automated Roller Blinds with Motors

Mono block roller blinds are installed together with the joinery. Mono blocks cannot be installed to current windows. They are produced in 3 types.

- Manual mono block roller blinds
- Semi-automatic mono block roller blinds with motor
- Full-automatic mono block roller blinds with motor

There are no motors in manual mono block roller blinds. They are moved by hand via pulling a chord. Movement of roller blinds up or down is made by pulling the chord. There are motors in semi and full automatic mono block roller blinds. They work with electricity. The key placed on the wall next to the semi-automatic roller blinds is used to start their movement. For full automatic mono block roller blinds with motor, there is a remote controller. In this system it is possible to start the roller blinds in the same systems together or separately.



ALTERNATIVE
SYSTEMS

Winhouse converts the function of windows to comfort with alternative systems. Automatic Sliding Systems, Folding Window and Door, Pivot and Adapter windows bring more oxygen and higher levels of isolation to your living spaces.



**AUTOMATIC
SLIDING**

Winhouse Automatic Slidings provide perfect heat and sound isolation while closing big gaps and the system is available in two different types as semiautomatic and full-automatic. Special accessories and car systems used in the system provide that even the huge shredding pieces are moved easily and the heat and sound insulation levels which are provided with normal window systems can be provided by the automatic sliding system with the locking systems usable in the 4 sides of the wing. The automatic sliding systems which are generally used in big balcony and the doors opening out the gardens enlighten the places they are applied to and since glass material is used in the system mostly, it does not block the garden and balcony sights. Winhouse automatic sliding systems are an instructional element of your house thanks to its advantages in insulation.



**FOLDING
WINDOW
AND DOOR**

Just like automatic sliding systems, Winhouse Folding Window and Door Systems are preferred in terrace balconies and large gaps opening out to the gardens. The system which can be used to close the gaps larger than the ones closed with automatic sliding systems stands out with its heat and sound insulation. Large gaps such as 1 stable 3 folding wings or 1 stable 5 folding wings depending on the window sizes are applied without giving up on the features such as comfort and aesthetics. Thanks to the stable wing used in folding door systems, entering into and exiting from the places are possible without opening the other wings. When the wings are folded, they are gathered in the side and when they are open, the place has a gap as if there were no windows.



**PIVOT
WINDOWS**

While Winhouse Pivot Windows systems are especially used for kitchen, lounge, corridor and attics in the houses, they are also preferred as original solutions for many structures built for different purposes. Thanks to wing action by 360° enabled at both horizontal and vertical position with their opposite hinges at the centre point and their ventilation position, Pivot Window Systems provides advantages of practical and original use in your buildings. They give sense of comfort, spaciousness and immensity indoor spaces with their square, rectangular and circular forms; they also provide excellent acoustic and heat insulation.



**DOUBLE SASH
TURN ONLY
WINDOWS**

Double sash turn only windows which are used not to block the view and to create a well-lighted area in the high rises, provide that the window gap opens when both of the wings are opened thanks to its mobile meeting rail. The most important feature of the windows which can be applied from the base to the ceiling inside the house, thanks to special accessories and locking systems used, is that it provides light inside the house even when they are closed and there is window gap when wings are opened thanks to its espagnolette system which enables both of the wings to open. While window handles can be used on both of the window wings in the double sash turn only systems, the appearance of two handles can be made to look more aesthetic by applying handle to one wing and hidden crowbar to the other wing. In the double sash turn only windows which can be used without any problems with the insulation, installing the window to the interior wall without any gaps is the best choice to be able to use the window at optimum levels.



PROJECTS



ALTIN İŞ KONAKLARI, BURSA



BEYKENT LOCCA, İSTANBUL



DEKORKENT, MARDİN



FENER EVLERİ, RİZE



PRESTIGE LIFE, İZMİR



Türkoba Mah. Fırat Plastik Cad. 23
Büyüçekmece 34537 İstanbul Turkey

FIRAT

T 0090 (212) 866 41 41 | 866 42 42
444 9 378 (FRT) | 0 800 219 80 20 **CUSTOMER SERVICE**
F 0090 (212) 859 04 00 | 859 05 00
E firat@firat.com | info@firat.com
winhouse@firat.com | musterihizmetleri@firat.com

www.firat.com | www.winhouse.com.tr

FACEBOOK | **TWITTER** | **LINKEDIN** [firatplastik](#)

